



**Delivering
POWER.**

BANK OF AMERICA MERRILL LYNCH 2017 AUTO SUMMIT

APRIL 12, 2017

Forward Looking Statements



This report may contain forward-looking statements within the meaning of the Private Securities Litigation Reform Act of 1995, including, without limitation, statements with respect to the acquisition of MPG and the anticipated consequences and benefits of such acquisition and other information relating to matters that are not historical facts. These forward-looking statements involve certain risks and uncertainties that could cause actual results to differ materially from those expressed or implied by these statements. These risks and uncertainties include the ability to successfully operate and integrate MPG operations and realize estimated synergies, and the other factors detailed in the reports we file with the SEC, including those described under “Risk Factors” in our most recent Annual Report on Form 10-K and our Quarterly Reports on Form 10-Q. These forward-looking statements speak only as of the date of this communication. We expressly disclaim any obligation or undertaking to disseminate any updates or revisions to any forward-looking statement contained herein to reflect any change in our expectations with regard thereto or any change in events, conditions or circumstances on which any such statement is based.

Information with respect to MPG, including non-GAAP information, is taken or derived from MPG’s public filings and management estimates and we take no responsibility for the accuracy or completeness of such information. It should also be noted that this presentation contains certain financial measures, including Adjusted EBITDA and Adjusted free cash flow, that are not required by, or presented in accordance with, accounting principles generally accepted in the United States, or GAAP. These measures are presented here to provide additional useful measurements to review our operations, provide transparency to investors and enable period-to-period comparability of financial performance. A description of non-GAAP financial measures that we use to evaluate our operations and financial performance, and reconciliation of these non-GAAP financial measures to the most directly comparable financial measures calculated and reported in accordance with GAAP, can be found starting on slide 36 under “Reconciliation of Non-GAAP Measures”.

Agenda

- AAM Highlights and Targets
- Industry Trends and Technology Leadership
- Acquisition of MPG



**Delivering
POWER.**

AAM HIGHLIGHTS AND TARGETS

2016 AAM Highlights

AAM Financial Records

Net Sales

\$3.95B

**Adjusted
EBITDA***

\$619.4M

15.7% of sales

Improved Net Leverage

**Strong Adj. Free
Cash Flow*
Generation**

\$198.6M

**Net Debt* /
Adj. EBITDA**

1.5x



**NEW
BUSINESS
AWARDS
for 2016**

SUCCESSFUL LAUNCHES IN 2016



Sales Growth and Operational Performance

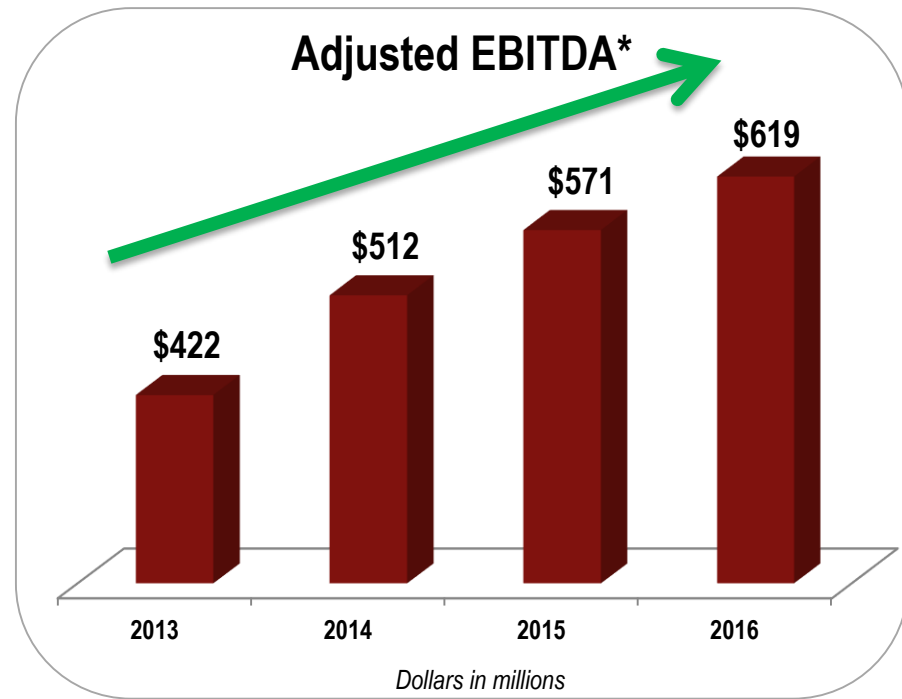
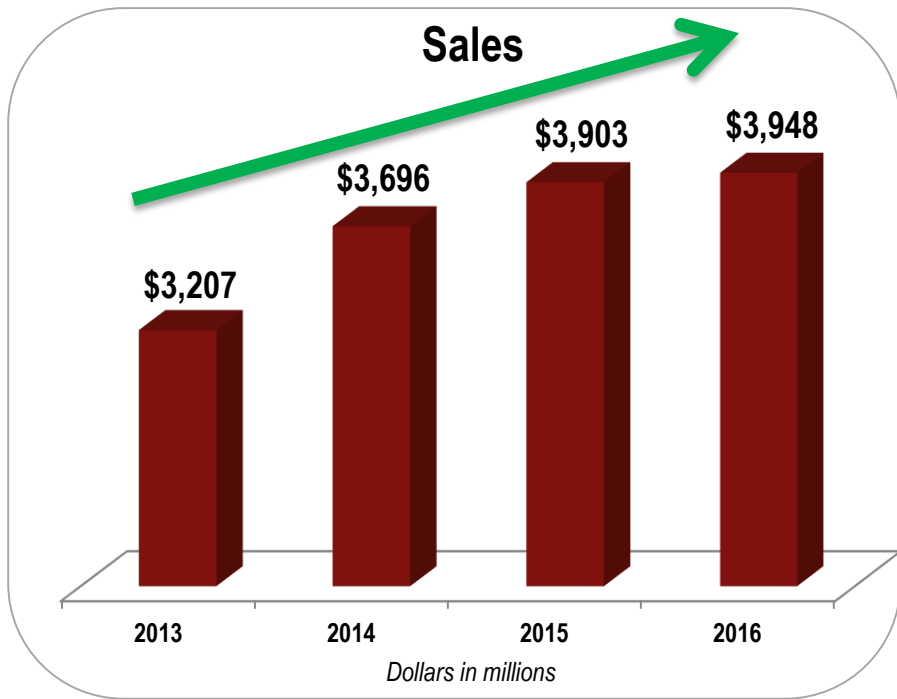

Three straight years of record sales and operating profits

* For definitions of terms, please see the attached appendix.

Free Cash Flow (FCF) & Leverage

Cumulative Adjusted FCF* since 2013

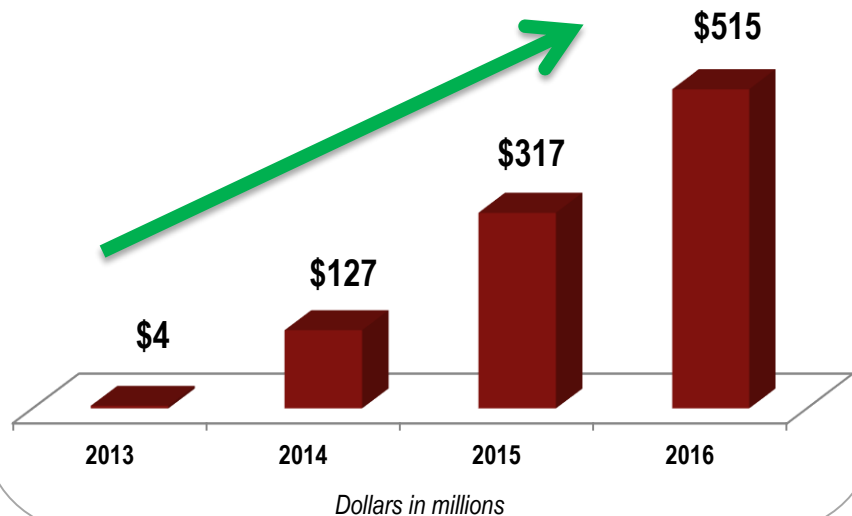

Net Leverage Ratio*

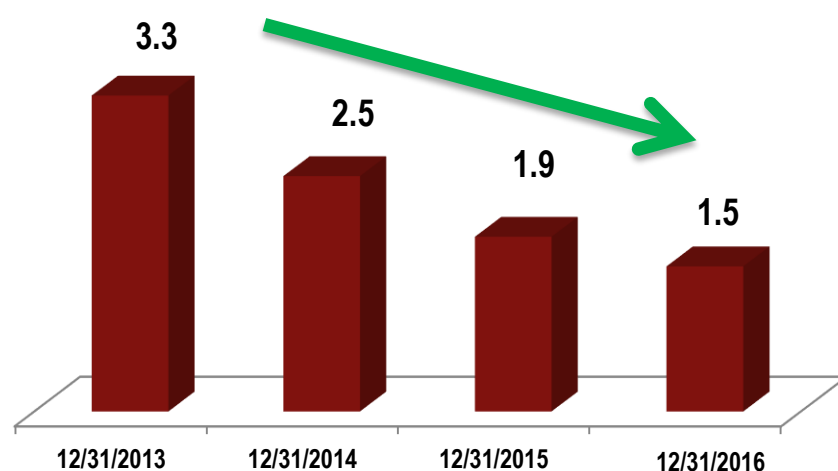

- **Generating robust free cash flow**
- **Rapid deleveraging of the balance sheet**

Completion of MPG Acquisition

Nearly



Annual Revenues

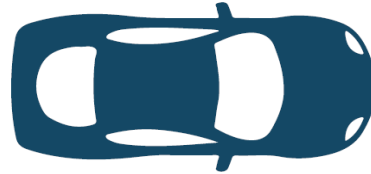

Diversification

- Customer Base
- Product Portfolio
- Geographic Footprint
- Served Market
- Vehicle Segments



Presence in
17 Countries



90 Facilities +



25,000 Associates

The acquisition of MPG was completed on April 6, 2017

Significantly Enhanced Scale and Profitability

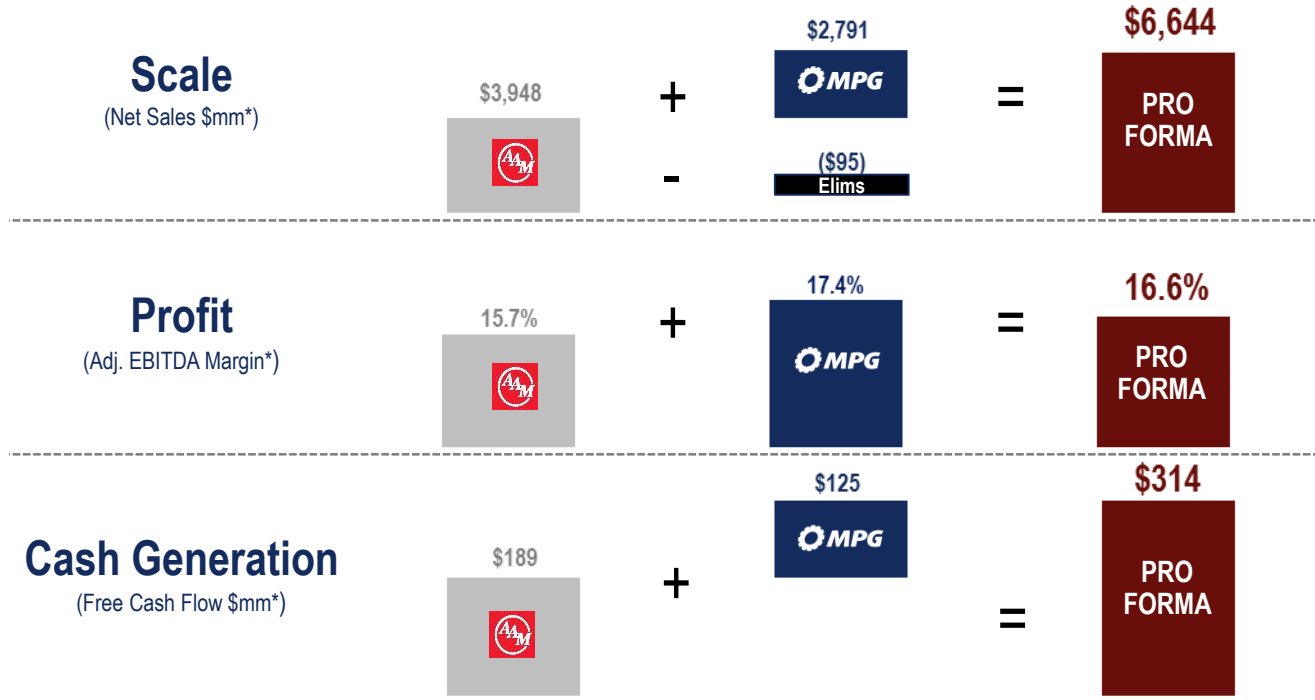

- Significant increase in total served market
- Content on 90% of light vehicles produced in North America and on all of the top 10 North American platforms
- Assuming successful execution of our cost reduction synergy plan - potential to generate **over \$400 million** in annual free cash flow

Greater capital resources create long-term value for stakeholders

*Based on 2016 Actuals – Pro forma sales are reduced by \$95 million for the elimination of 2016 MPG sales to AAM; for definitions of terms, please see the attached appendix

Combined Pro Forma Financial Targets

As presented on November 17, 2016



Pro Forma Targets 2017 – 2019

Sales CAGR*

Targeting a range of 3% to 5% during the period 2017 – 2019

including the impact of launching over \$1 billion of gross new and incremental business backlog

Adj. EBITDA* margin

Targeting a range of 17% to 18% of sales by 2018

including the achievement of \$100 to \$120 million in cost reduction synergies

Adj. Free Cash Flow*

Targeting a range of 5% to 7% of sales through 2019

**Capital Expenditures
(Cap Ex)**

Targeting \approx 8% of sales in 2017, reducing to < 6% of sales by 2019

Updated 2017 targets to be communicated as part of Q1 earnings release

Pro Forma Debt Reduction Target

As presented on November 17, 2016

Pro Forma Net Debt* and Net Leverage Ratio*

Liquidity⁽¹⁾

Debt Maturities⁽²⁾

Net Debt and Net Leverage Ratio

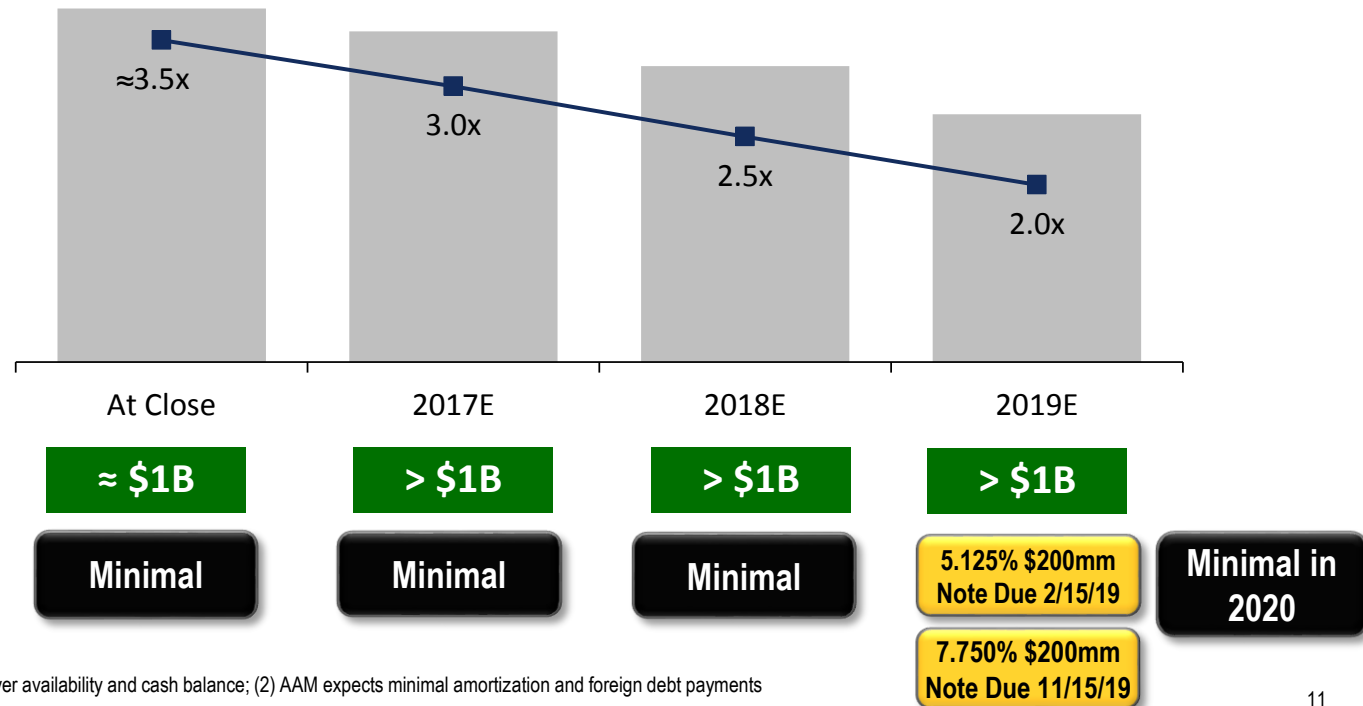

Note: Reflects company targets; (1) Reflects combined revolver availability and cash balance; (2) AAM expects minimal amortization and foreign debt payments

*For definitions of terms, please see the attached appendix≈



**Delivering
POWER.**

INDUSTRY TRENDS AND TECHNOLOGY LEADERSHIP

US SAAR and NA Production Assumptions

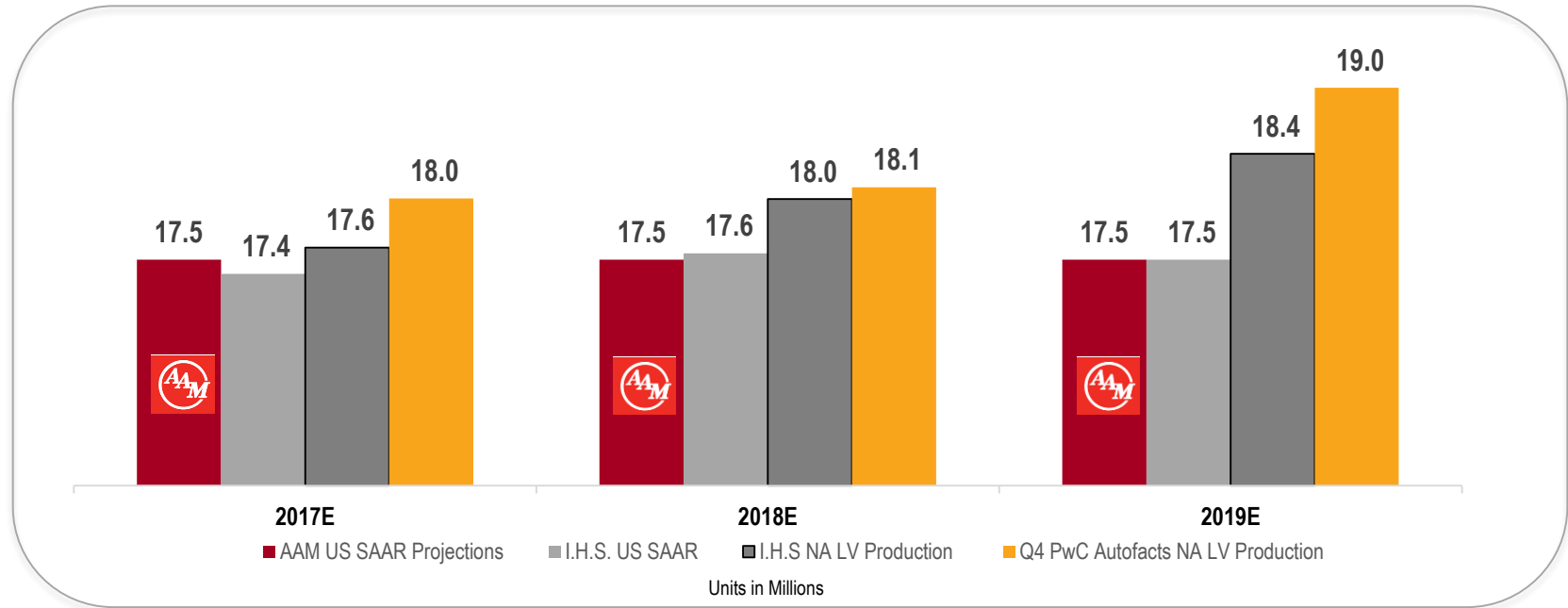

- AAM assumes US SAAR to be approximately 17.5 million units over the next three years
- I.H.S / PwC Autofacts estimate an increase in North American production due to growing exports
- AAM also assumes a moderate recovery in the commercial vehicle and industrial markets during this time period.

Powertrain Projections

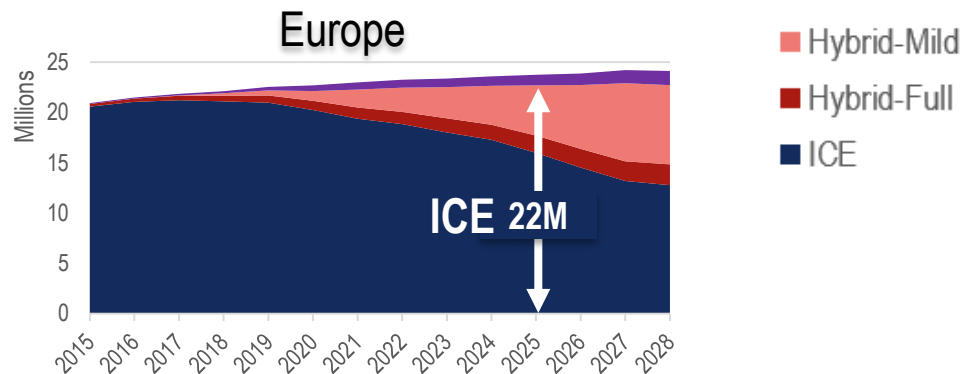
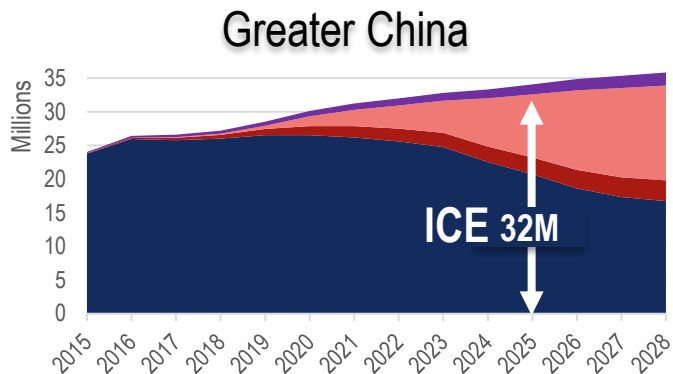
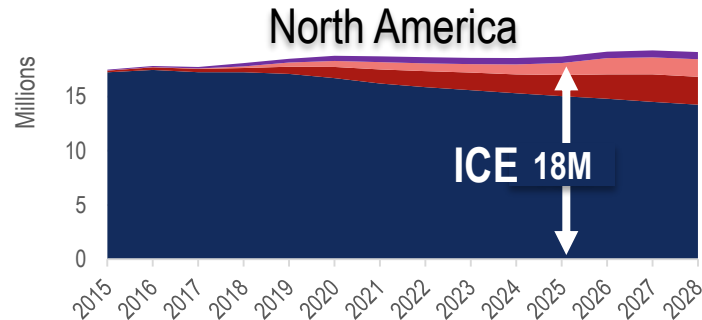
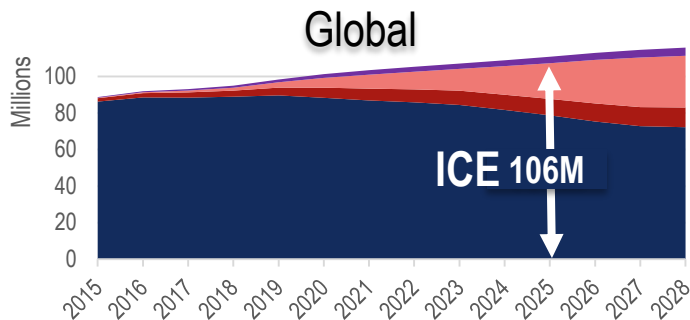

- Electric
- Hybrid-Mild
- Hybrid-Full
- ICE

For at least the next decade, the internal combustion engine (ICE) is expected to be the main source of power for vehicles

North America Light Vehicle Production Mix

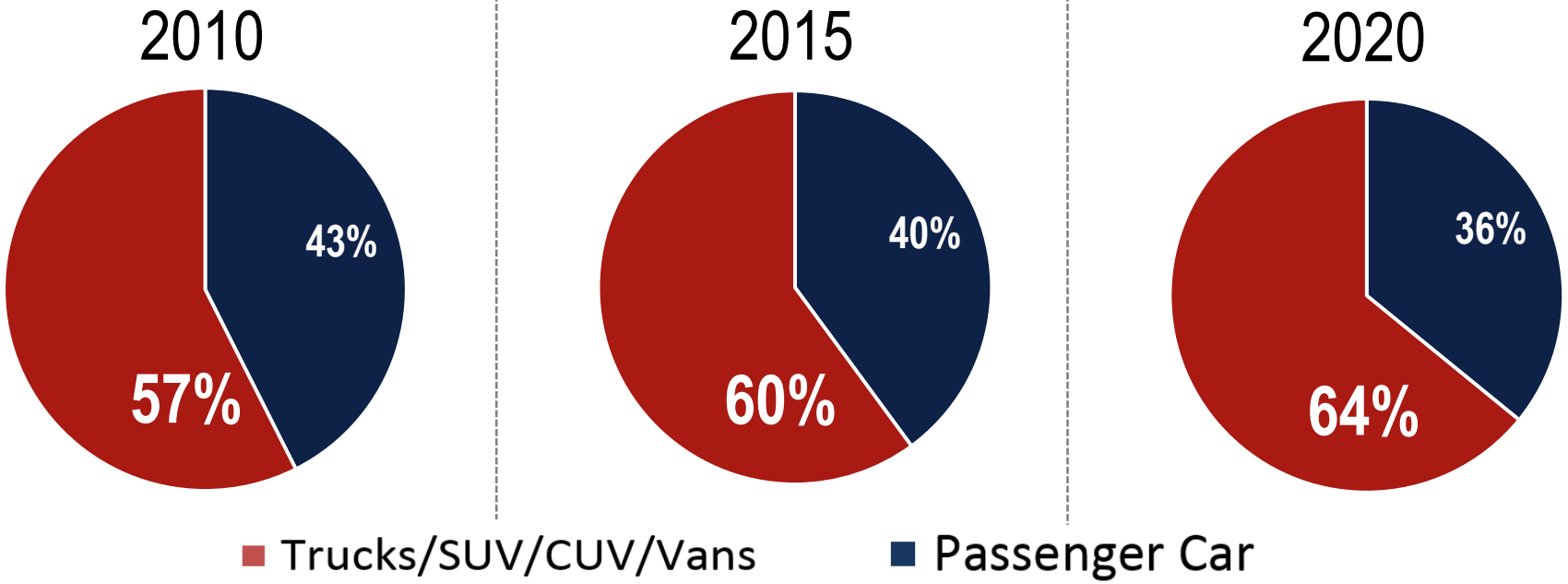

Continued strength in pickup trucks/SUVs and increasing demand for crossover vehicles is favorable for AAM

Technology Leadership: The Power of Innovation



GREEN and EFFICIENT

- High efficiency axle portfolio and all-new QUANTUM™ lightweight axles and drive units
- New product designs and manufacturing processes leading to light-weighting and cost savings
- Power dense technology allows forged products to maintain strength and quality within a smaller design
- Use of advanced materials



SAFETY and PERFORMANCE

- EcoTrac® disconnecting AWD system
- Driveshaft technologies incorporate noise, vibration, and harshness (NVH) system integration and tunable crash features
- Precision-ground gears with dampening capability improve NVH
- Vibration control systems provide solutions to offset vibration inherent in downsized engines



CONNECTIVITY and ELECTRIFICATION

- e-AAM™ hybrid & electric driveline systems
- Actuators and sensors
- Electronic LSD front-drive axles
- Integrated wheel torque distribution controls
- Fully integrated vehicle controls



Aligned with global automotive trends

Comprehensive Solutions from Engine to Driveline



- Rear and front axles
- Rear drive modules
- Power transfer units
- Driveshafts
- Transfer cases
- Electric drive units
- Ring / pinion gears
- Axle / transmission shafts
- Differential gears
- Transmission gears



- Axle carriers
- Differential cases
- Control arms
- Turbo charger housings
- Brackets
- Suspension components
- Transmission modules
- Differential assemblies
- Aluminum valve bodies
- Vibration control systems
- Connecting rods
- VVT products

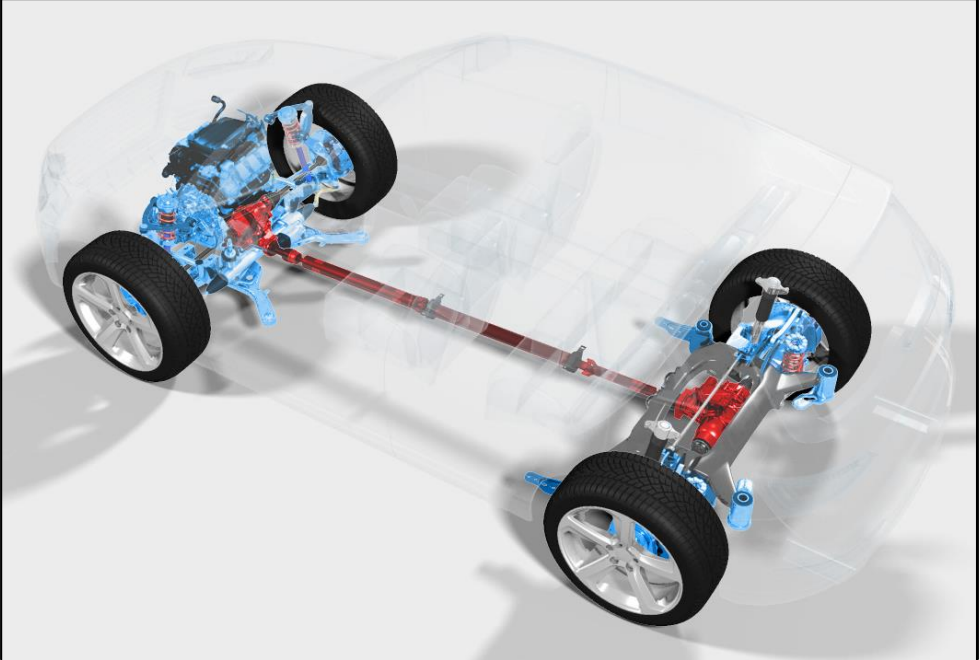

The integration of our product portfolios and technologies provides exciting opportunities to increase content-per-vehicle

EcoTrac[®] Disconnecting AWD Systems



EcoTrac[®] - utilizes electronics and connectivity to improve Fuel Economy, Safety, and Performance

KEY ATTRIBUTES

- Advanced mechatronics (motors, actuators and sensors) integrated within mechanical technology
- Disconnects at the power transfer unit (PTU), causing the driveshaft to stop spinning
- Can automatically engage when it senses AWD traction requirement
- Benefits:
 - Improved vehicle fuel economy without sacrifice in AWD functionality
 - Improved vehicle handling and safety
 - Our Gen II design, which begins production in 2018, will reduce the parasitic loss associated with traditional AWD system by 90%

ECO TRAC
DISCONNECTING AWD SYSTEM BY 



EcoTrac[®] Disconnecting PTU

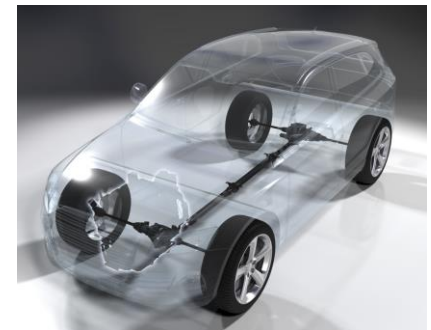

EcoTrac[®] Sales Growth

**54% CAGR
from 2013
to 2019!**

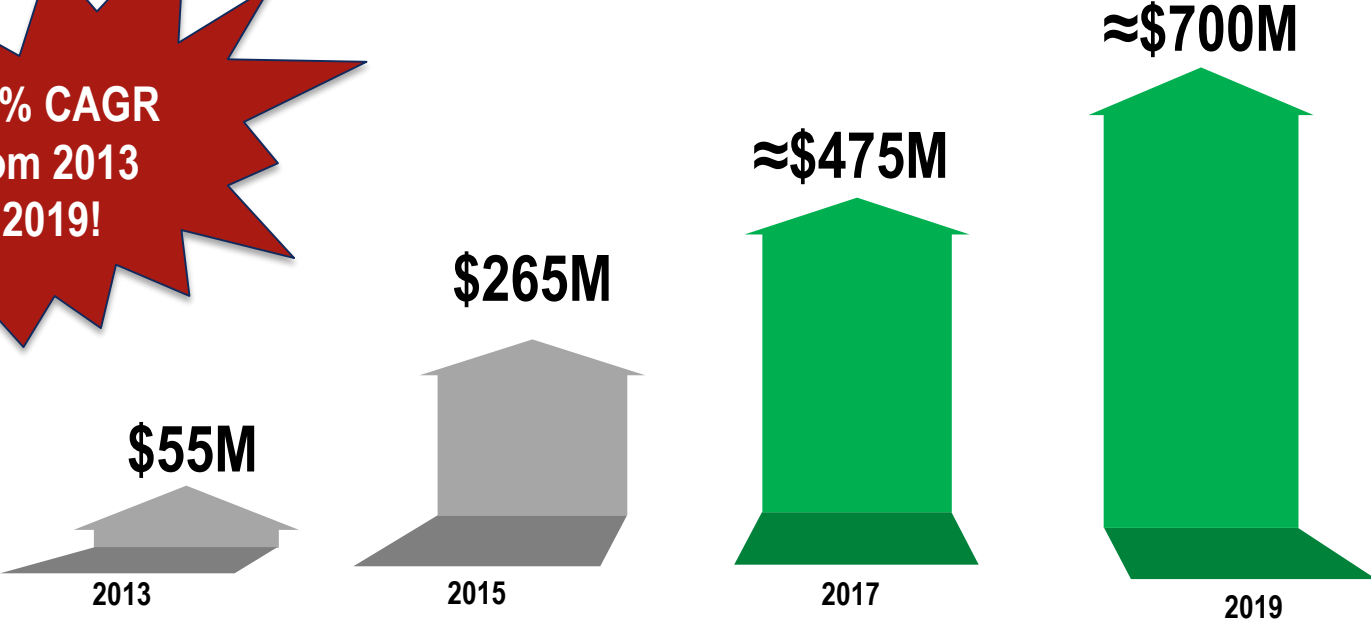

Featured on three global programs by 2018

e-AAM™ Hybrid & Electric Drivelines



e-AAM™ - AAM is well positioned to benefit from the global trend of electrification

KEY ATTRIBUTES

- Power dense design allows for easy integration for multiple vehicle platforms
- Modular solutions for passenger cars / CUVs
- Torque vectoring provides maximum traction and ride control
- Benefits:
 - Improves fuel efficiency up to 30% and reduces CO₂ emissions
 - Improved vehicle performance and drive quality
 - Improved handling and stability

e
AAM

HYBRID AND ELECTRIC
DRIVELINE SYSTEMS BY 



Electric Rear Drive Unit



An e-AAM program included in our new business backlog will launch in 2018

QUANTUM™ - All-new, completely redesigned family of lightweight axles and drive units

KEY ATTRIBUTES

- Industry first technology along with a revolutionary design
- Significant mass reduction (up to 35%)
- In combination, additional efficiency and weight reduction can deliver 1% to 1.5% improved vehicle fuel economy
- Scalable across multiple applications— without loss of performance or power
- Streamlined manufacturing process for key driveline components.

QUANTUM™
LIGHTWEIGHT AXLE TECHNOLOGY BY 



QUANTUM™ Rear Axle

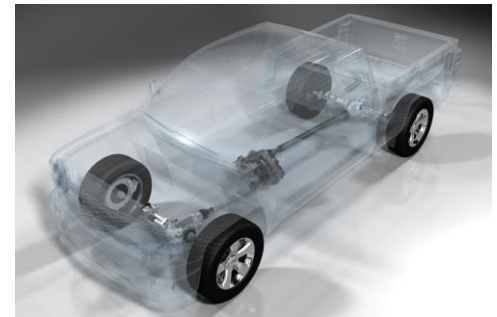

High Performance Powertrain Components



Light Weighting

Old Design



New Design



Savings:

- 40% weight savings
- 25% anticipated cost savings

Strength

Old Design



New Design



Gear technology maintains strength in a smaller gear design

Noise Reduction



Precision-ground gears with dampening capability improve NVH

Vibration Control



Solutions to offset vibration inherent in downsized engines



**Delivering
POWER[®]**

AAM'S ACQUISITION OF MPG

(METALDYNE PERFORMANCE GROUP)

Increased Global Scale | Expanded Product Portfolio | Accelerated Diversification | Enhanced Cash Flow Generation

Compelling Strategic Acquisition



Creates a
Global leader in
powertrain,
drivetrain and
driveline

Diversified
global customer
base
and end markets

Complementary
technologies
focused on
light-weighting,
fuel efficiency,
vehicle safety and
performance solutions

Stronger
financial profile
through greater size,
scale and enhanced
cash flow
generation

Powerful **Industrial**
logic and significant
synergies

Driving growth and long-term value for all key stakeholders

Combined Company Business Units

DRIVELINE



- Rear and front axles
- Rear drive modules
- Power transfer units
- Driveshafts
- Transfer cases
- Electric drive units

≈ \$3.7 billion

METAL FORMING



- Ring / pinion gears
- Axle / transmission shafts
- Differential gears
- Transmission gears
- Suspension components

≈ \$1.5 billion

POWERTRAIN



- Transmission module and differential assemblies
- Aluminum valve bodies
- Vibration control systems
- Connecting rods
- VVT products

≈ \$1.1 billion

CASTINGS



- Axle carriers
- Differential cases
- Steering knuckles
- Control arms
- Turbo charger housings
- Brackets

≈ \$800 million

Expanded Product Portfolio

- Additional powertrain, forging and casting products build on AAM's legacy driveline strength
- Expands AAM's reach into commercial vehicle and industrial equipment markets
- AAM's reliance on GM's full-size truck and SUV segment is significantly reduced

AAM 2016 External Sales by Product

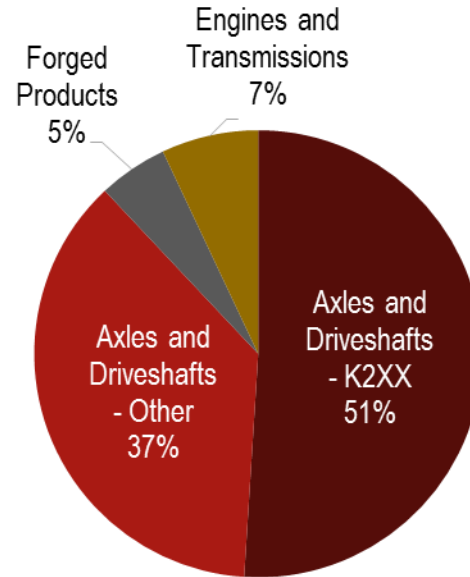

Pro forma 2016 External Sales by Product

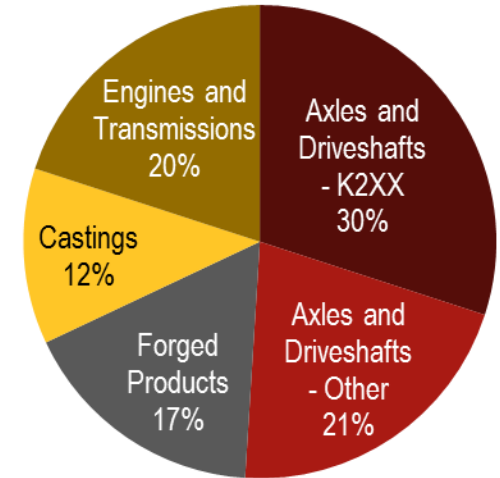

Accelerated Customer Diversification

AAM 2016 Sales by Customer

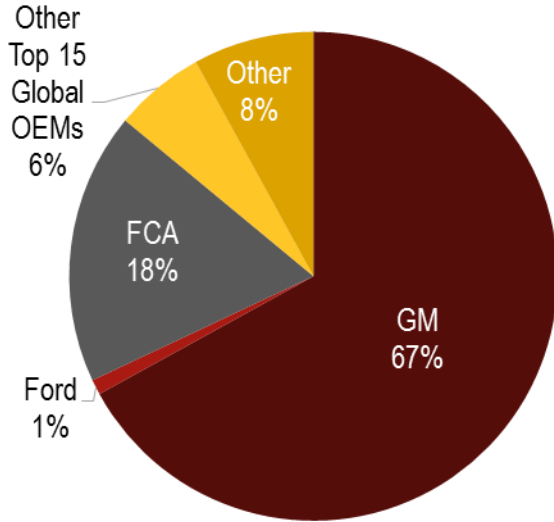

Pro forma 2016 Sales by Customer

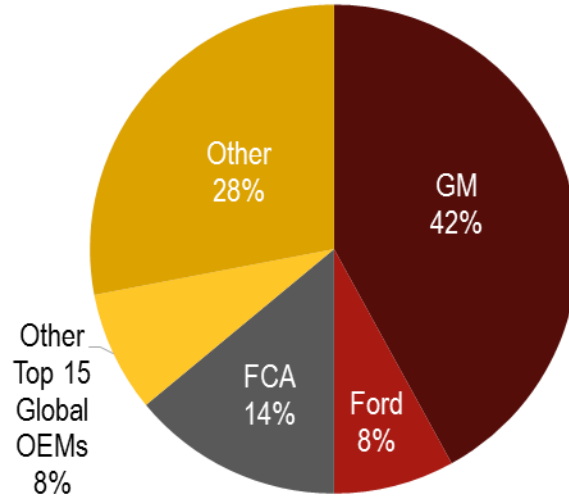

Pro forma 2020E Sales by Customer

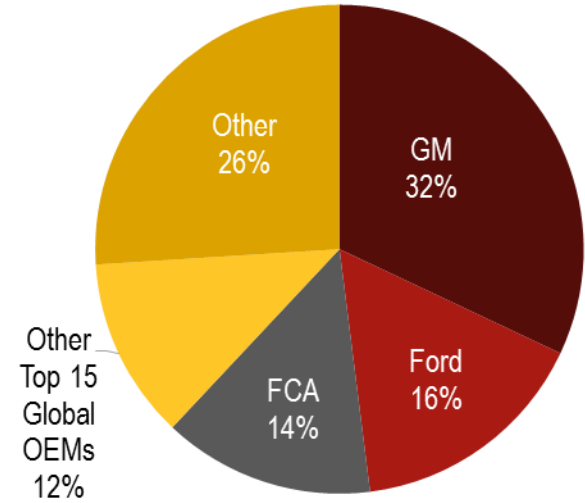

* Top 15 Global OEMs determined based on total 2015 sales

Enhanced Geographic Footprint

- Combined company grows to over 90 locations in 17 countries
- Diversifies global customer base and end markets
- AAM's sales in Europe increase > 4x
- MPG's focus on growth in Mexico and China complementary to AAM's global growth strategy
- Global forging business presents external growth and vertical integration opportunity

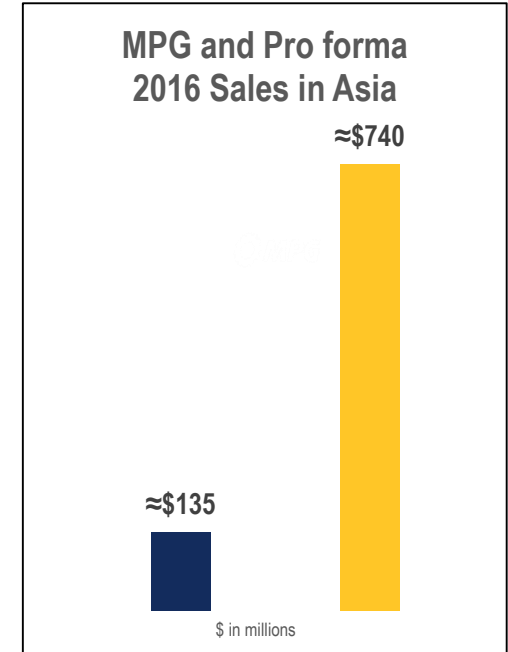
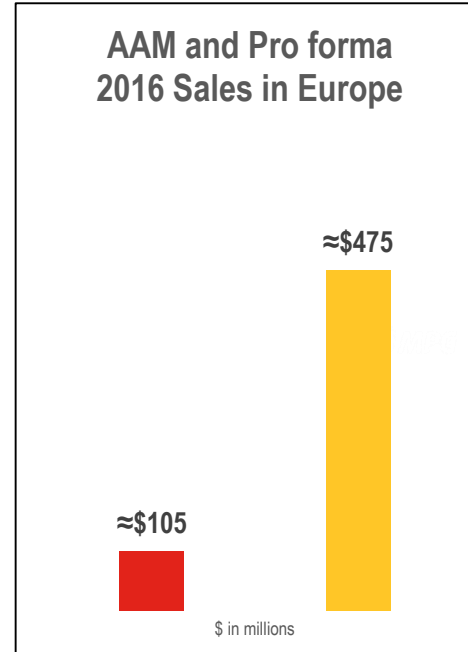

Expanded global reach will further enhance AAM's ability to support customers' global platform needs

Strong Organic Sales Growth Expected

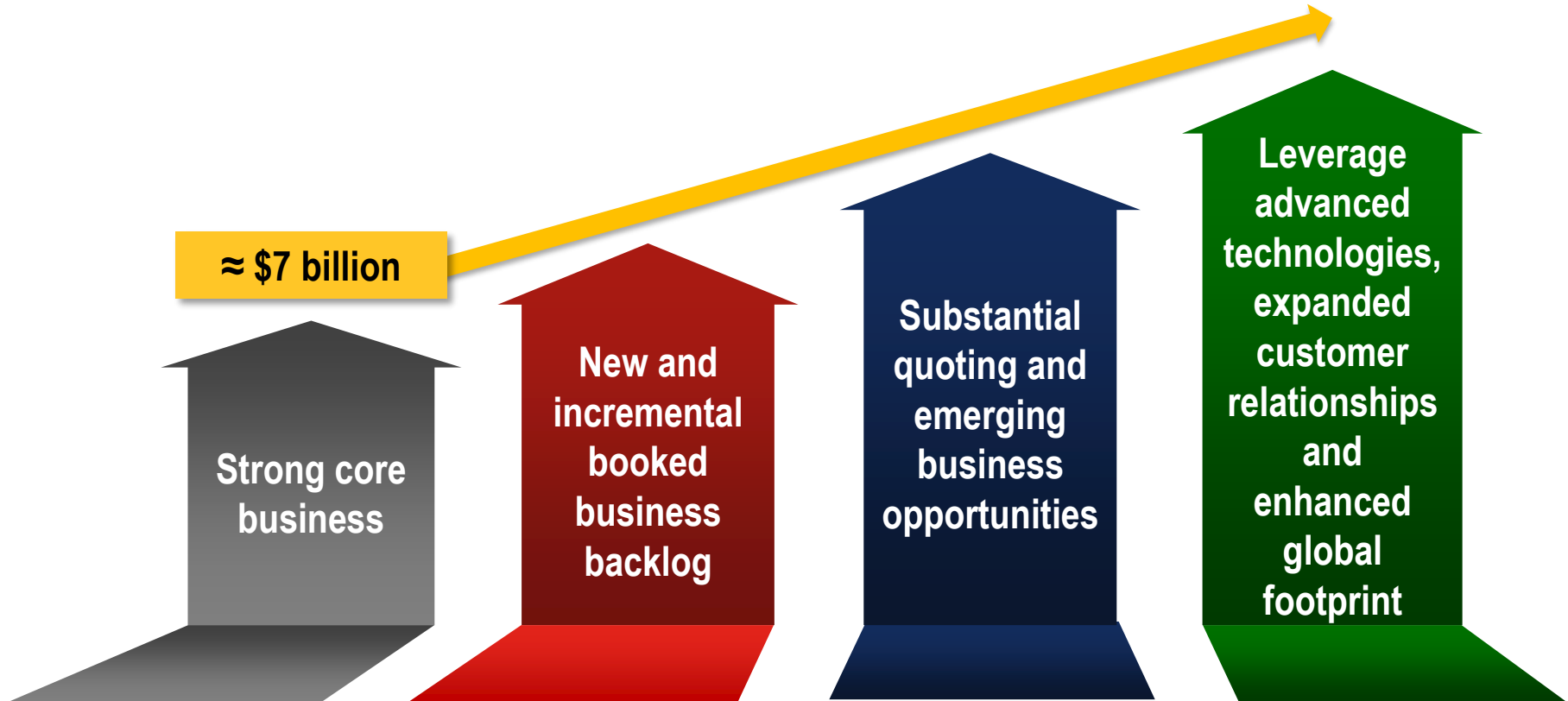

Integration Management Office (IMO)

Goals of the IMO:

- Manage and effectively communicate integration plan
- Protect customer launches and future programs
- Lead change management and cultural integration activities
- Drive synergy capture of \$100 - \$120 million in annual cost reduction savings



Anticipated Synergies

Sources of Cost Savings	Targeted Annual Profit Impact
Overhead <ul style="list-style-type: none">Optimize operating structureElimination of redundant public company costs	≈ \$45 - \$50 million
Purchasing <ul style="list-style-type: none">Combine global purchasing to leverage larger scaleDirect and indirect material opportunitiesInsourcing initiatives	≈ \$45 - \$50 million
Other Cost Savings <ul style="list-style-type: none">Manufacturing initiativesPlant loading optimization / facility rationalization	≈ \$10 - \$20 million
Total Targeted Annual Improvement	≈ \$100 - \$120 million

Timing and Cost to Achieve

Targeting 70% of expected annual run rate savings by the end of the first full year and 100% in the second full year

We estimate the costs required to achieve our synergy plan are approximately equal to one year of savings

Expected Pro Forma EBITDA vs. Cash Payments



- Targeting Adjusted EBITDA well above projected cash requirements
- Variable cost structure allows for flexibility during periods of lower volumes
- Positioned to be cash breakeven in a 25% - 30% downturn scenario

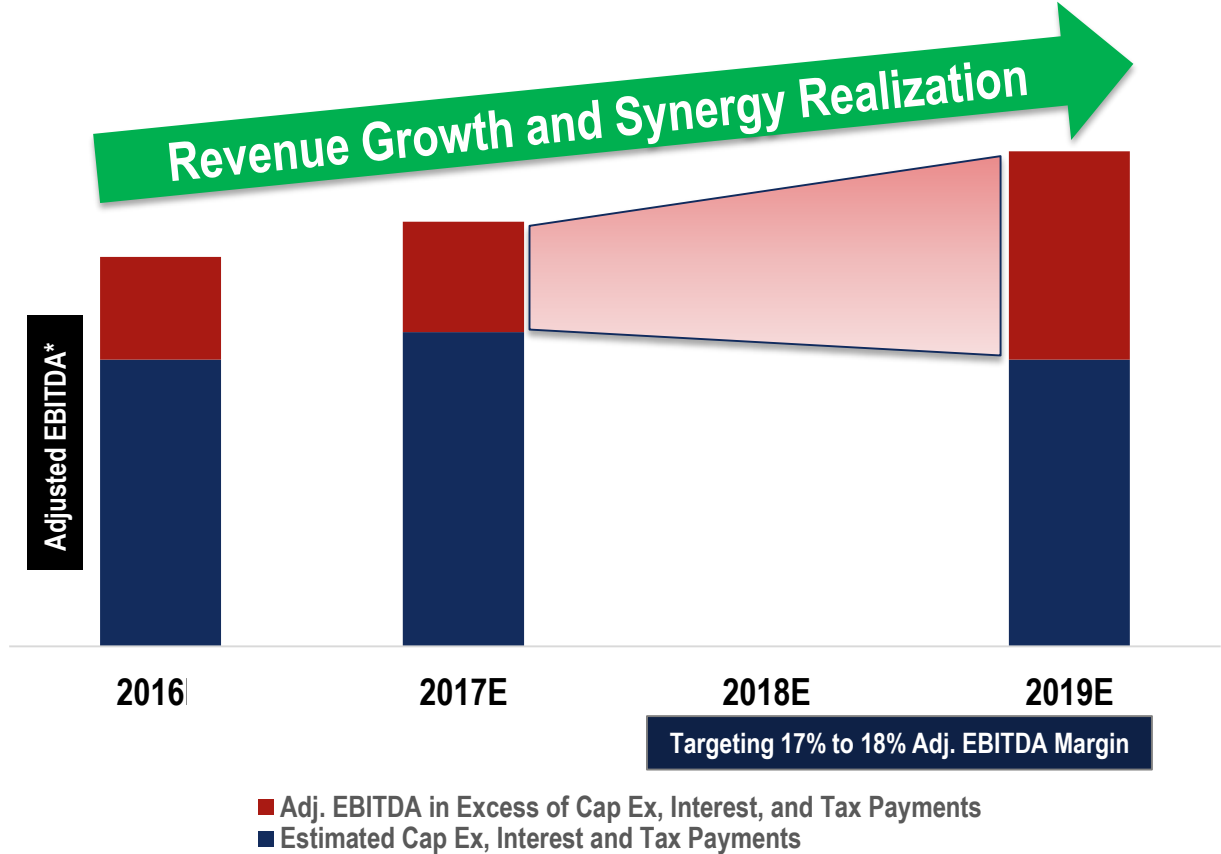

*For definitions of terms, please see the attached appendix



- Increased size and scale
- Customer and product diversification
- Enhanced geographic footprint
- Served market and content per vehicle expansion
- Strong profit and free cash flow margins
- Identifiable cost synergies of ≈\$100 – 120 million
- Extended debt maturity profile
- Strong liquidity position

Stronger Financial Profile and Enhanced Cash Flow Generation



**Delivering
POWER.**

Q&A



**Delivering
POWER.**

APPENDIX

Reconciliation of Non-GAAP Measures



In addition to the results reported in accordance with accounting principles generally accepted in the United States of America (GAAP) included within this presentation, we have provided certain information, which includes non-GAAP financial measures. Such information is reconciled to its closest GAAP measure in accordance with Securities and Exchange Commission rules and is included in the following slides.

Certain of the forward-looking financial measures included in this presentation are provided on a non-GAAP basis. A reconciliation of 2017 non-GAAP targets and pro forma forward-looking financial measures to the most directly comparable financial measures calculated and presented in accordance with GAAP is not practical given the difficulty of projecting event driven transactional and other non-core operating items in any future period. The magnitude of these items, however, may be significant.

Reconciliation of Non-GAAP Measures



American Axle & Manufacturing Holdings, Inc.

Earnings before Interest, Income Taxes, Depreciation and Amortization (EBITDA) and Adjusted EBITDA

(\$ in millions)

	2016	2015	2014	2013
Net income attributable to shareholder	\$ 240.7	\$ 235.6	\$ 143.0	\$ 94.5
Interest expense	93.4	99.2	99.9	115.9
Income tax expense	58.3	37.1	33.7	(8.2)
Depreciation and amortization	201.8	198.4	199.9	177.0
EBITDA	\$ 594.2	\$ 570.3	\$ 476.5	\$ 379.2
Restructuring and acquisition-related costs, debt refinancing and redemption costs and non-recurring items	25.2	0.8	35.5	42.6
Adjusted EBITDA	\$ 619.4	\$ 571.1	\$ 512.0	\$ 421.8
as % of net sales	15.7 %	14.6 %	13.9 %	13.2 %

Reconciliation of Non-GAAP Measures



American Axle & Manufacturing Holdings, Inc.

Free cash flow and Adjusted free cash flow

(\$ in millions)

	2016	2015	2014	2013
Net cash provided by operating activities	\$ 407.6	\$ 377.6	\$ 318.4	\$ 223.0
Less: Purchases of property, plant & equipment, net of proceeds from sale of property, plant & equipment and from government grants	(218.5)	(188.1)	(195.3)	(218.7)
Free cash flow	\$ 189.1	\$ 189.5	\$ 123.1	\$ 4.3
Add: Cash payments for restructuring and acquisition-related costs	9.5	—	—	—
Adjusted free cash flow	\$ 198.6	\$ 189.5	\$ 123.1	\$ 4.3

Reconciliation of Non-GAAP Measures



American Axle & Manufacturing Holdings, Inc.

Net Debt and Net Leverage Ratio

(\$ in millions)

	at December 31,			
	2016	2015	2014	2013
Current portion of long-term debt	\$ 3.3	\$ 3.3	\$ 13.0	\$ —
Long-term debt, net	1,400.9	1,375.7	1,504.6	1,537.0
Total debt, net	1,404.2	1,379.0	1,517.6	1,537.0
Less: Cash and cash equivalents	481.2	282.5	249.2	154.0
Net debt at end of period	\$ 923.0	\$ 1,096.5	\$ 1,268.4	\$ 1,383.0
Net leverage ratio	1.5	1.9	2.5	3.3

Reconciliation of Non-GAAP Measures



2016 Full Year Earnings before Interest, Income Taxes, Depreciation and Amortization (EBITDA) and Adjusted EBITDA Reconciliation Schedule

(\$ in millions)

	AAM	MPG	COMBINED
Net income attributable to shareholders	\$ 240.7	\$ 96.3	\$ 337.0
Interest expense	93.4	103.5	196.9
Income tax expense	58.3	38.4	96.7
Depreciation and amortization	201.8	221.3	423.1
EBITDA	<u>\$ 594.2</u>	<u>\$ 459.5</u>	<u>\$ 1,053.7</u>
Restructuring and acquisition-related costs, debt refinancing and redemption costs and non-recurring items	25.2	24.7	49.9
Adjusted EBITDA	<u>\$ 619.4</u>	<u>\$ 484.2</u>	<u>\$ 1,103.6</u>
as % of net sales	<u>15.7 %</u>	<u>17.4 %</u>	<u>16.6 %</u>

Reconciliation of Non-GAAP Measures



2016 Full Year Free Cash Flow

(\$ in millions)

	<u>AAM</u>	<u>MPG</u>	<u>COMBINED</u>
Net cash provided by operating activities	\$ 407.6	\$ 318.6	\$ 726.2
Less: Purchases of property, plant & equipment, net of proceeds from sale of property, plant & equipment and from government grants	(218.5)	(194.0)	(412.5)
Free cash flow	<u>\$ 189.1</u>	<u>\$ 124.6</u>	<u>\$ 313.7</u>

Reconciliation of Non-GAAP Measures



We define EBITDA to be earnings before interest expense, income taxes, depreciation and amortization. Adjusted EBITDA excludes the impact of restructuring and acquisition related-costs, debt refinancing and redemption costs and non-recurring items. We believe EBITDA and Adjusted EBITDA are meaningful measures of performance as they are commonly utilized by management and investors to analyze operating performance and entity valuation. Our management, the investment community and banking institutions routinely use EBITDA and Adjusted EBITDA, together with other measures, to measure our operating performance relative to other Tier 1 automotive suppliers. EBITDA and Adjusted EBITDA should not be construed as income from operations, net income or cash flow from operating activities as determined under GAAP. Other companies may calculate EBITDA and Adjusted EBITDA differently.

We define free cash flow to be net cash provided by operating activities less capital expenditures net of proceeds from the sale of property, plant and equipment and government grants. Adjusted free cash flow excludes the impact of cash payments for restructuring and acquisition-related costs. We believe free cash flow and Adjusted free cash flow are meaningful measures as it is commonly utilized by management and investors to assess our ability to generate cash flow from business operations to repay debt and return capital to our stockholders. Free cash flow is also a key metric used in our calculation of incentive compensation. Other companies may calculate free cash flow and adjusted free cash flow differently.

We define net debt to be total debt, net less cash and cash equivalents. We define net leverage ratio to be net debt divided by Adjusted EBITDA. We believe that net leverage ratio is a meaningful measure of financial condition as it is commonly used by management, investors and creditors to assess capital structure risk. Other companies may calculate net leverage ratio differently.

We define US SAAR as the seasonally adjusted annual rate of light vehicle sales in the United States

We define CAGR to be the compound annual growth rate of sales.