



Investor Presentation

January 2019

Forward Looking Statements



This presentation contains forward-looking statements within the meaning of the Private Securities Litigation Reform Act of 1995. These forward-looking statements involve certain risks and uncertainties that could cause actual results to differ materially from those expressed or implied by these statements. These risks and uncertainties include factors detailed in the reports we file with the SEC, including those described under “Risk Factors” in our most recent Annual Report on Form 10-K and our Quarterly Reports on Form 10-Q. These forward-looking statements speak only as of the date of this communication. We expressly disclaim any obligation or undertaking to disseminate any updates or revisions to any forward-looking statement contained herein to reflect any change in our expectations with regard thereto or any change in events, conditions or circumstances on which any such statement is based.

It should also be noted that this presentation contains certain financial measures, including Adjusted EBITDA, Adjusted Earnings per Share, Adjusted Free Cash Flow, and Net Leverage Ratio that are not required by, or presented in accordance with, accounting principles generally accepted in the United States, or GAAP. These measures are presented here to provide additional useful measurements to review our operations, provide transparency to investors and enable period-to-period comparability of financial performance. A description of non-GAAP financial measures that we use to evaluate our operations and financial performance, and reconciliation of these non-GAAP financial measures to the most directly comparable financial measures calculated and reported in accordance with GAAP, can be found in the appendix under “Reconciliation of Non-GAAP Measures”.

About AAM



AAM is a premier, global leader in design, engineering, validation and manufacturing of driveline, metal forming, powertrain and casting technologies for automotive, commercial and industrial markets

ESTIMATED 2018 SALES

≈\$7.25B

Over

700

CUSTOMERS

AAM is **Delivering POWER** through world-class quality, technology leadership and operational excellence

16

ENGINEERING CENTERS

Over

25,000

ASSOCIATES



17
COUNTRIES

Over
85
LOCATIONS



Over

70

MANUFACTURING
FACILITIES





2018 Financial Update and Highlights

AAM's 2018 Financial Estimates



2018 Estimated Preliminary Results

Sales	≈ \$7.25 billion
Adjusted EBITDA* Margin	≈ 16.25% of sales
Adjusted Free Cash Flow*	≈ \$315 million

- We expect restructuring and acquisition-related payments to be approximately \$70 million for the full year 2018.
- Our annual goodwill impairment test is in process and we currently expect to record a non-cash impairment charge in the fourth quarter of 2018, which may be significant. We will exclude any goodwill impairment charge from our calculations of Adjusted EBITDA and Adjusted Earnings Per Share*.

Despite operational and launch challenges – AAM achieved strong financial performance in 2018

Performance Improvement Plans



3Q 2018 Issues

Status Update

Anticipated Exit Rate Status

Driveline

- Changes affecting build-out and launch
- Scrap performance
- Supplier delivery performance

- RAM HD prior model build out complete in December 2018, new model start of production begins in January 2019
- Improved scrap performance
- Resolution of 1 of 2 e-drive unit supplier issues
- Most other supplier delivery issues resolved

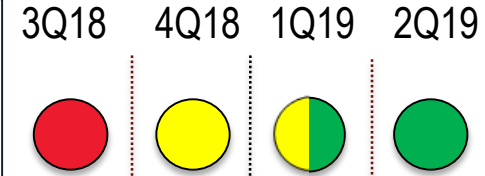

Metal Forming

- European capacity constraints

- Eliminated delivery past-due conditions



Powertrain

- Ineffective program management
- Launch performance
- Capacity constraints

- Accelerated implementation of IPM systems
- Reallocation of resources and restructuring of business unit accelerates integration
- In process of addressing capacity constraints

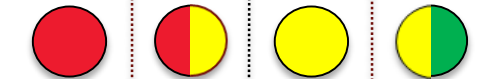

Casting

- Availability of labor
- Operational inefficiencies
- Inflationary pressures

- Continue to address manpower shortages
- Improved business performance
- Implementing customer pricing actions

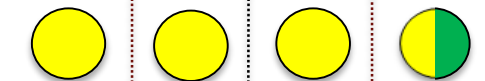

AAM is on track to meet these previously disclosed performance improvement goals

2018 AAM Highlights



Record Annual Sales – Over \$7 Billion for the first time in **AAM History**



AAM recognized as **Fortune 500 Company**

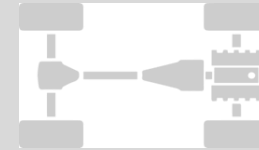

Sold Aftermarket division of our Powertrain BU for **\$50 million**



Formed joint venture with **Lizhou Wuling** in **China**



Met key **Integration Milestones**, including **Synergy Attainment**



Named **GM Supplier of the Year** for 2nd consecutive year



QUANTUM™ technology wins **Altair and SAA Lightweighting Awards**



5th New Business Award for our **Ecotrac™** Disconnecting AWD Technology



Strong cash flow generation and **Over \$200 Million** in senior debt payments



Business Strategy and Growth Update

Business Unit Consolidation

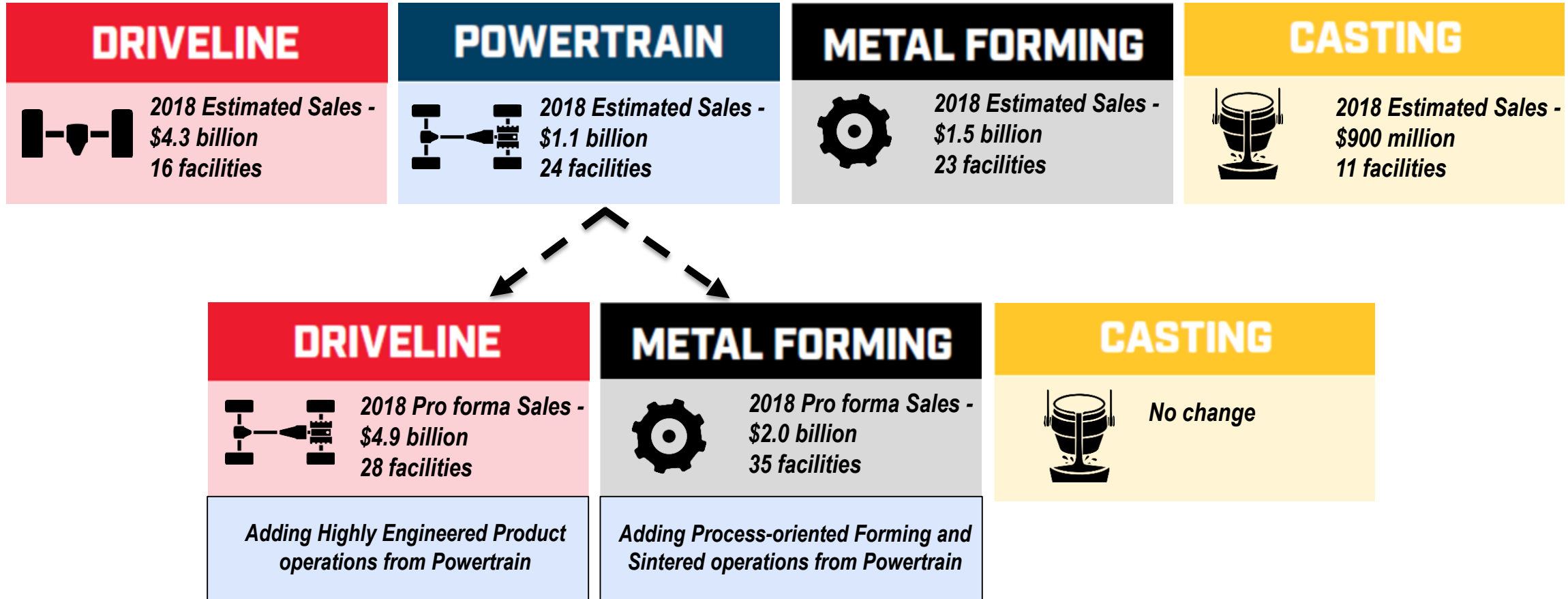

AAM is proactively streamlining our business by consolidating four business units into three

Note: 2018 sales are based on estimates and reflect approximately \$550 million of intercompany sales

Business Unit Consolidation Objectives



1 Finalize integration process

WE ARE 

2 Align AAM's product and process technologies



3 Achieve efficiencies within our corporate and business unit support teams



4 Accelerate implementation of AAM's Operating System including program management and launch readiness



5 Provide annual cost savings estimated at \$10 - \$20 million



6 Enhance our ability to adapt to constantly changing market conditions



Gross New and Incremental Business Backlog



\$1.25 BILLION: 2019 - 2021

as disclosed on January 15, 2019

Backlog by Vehicle Segment

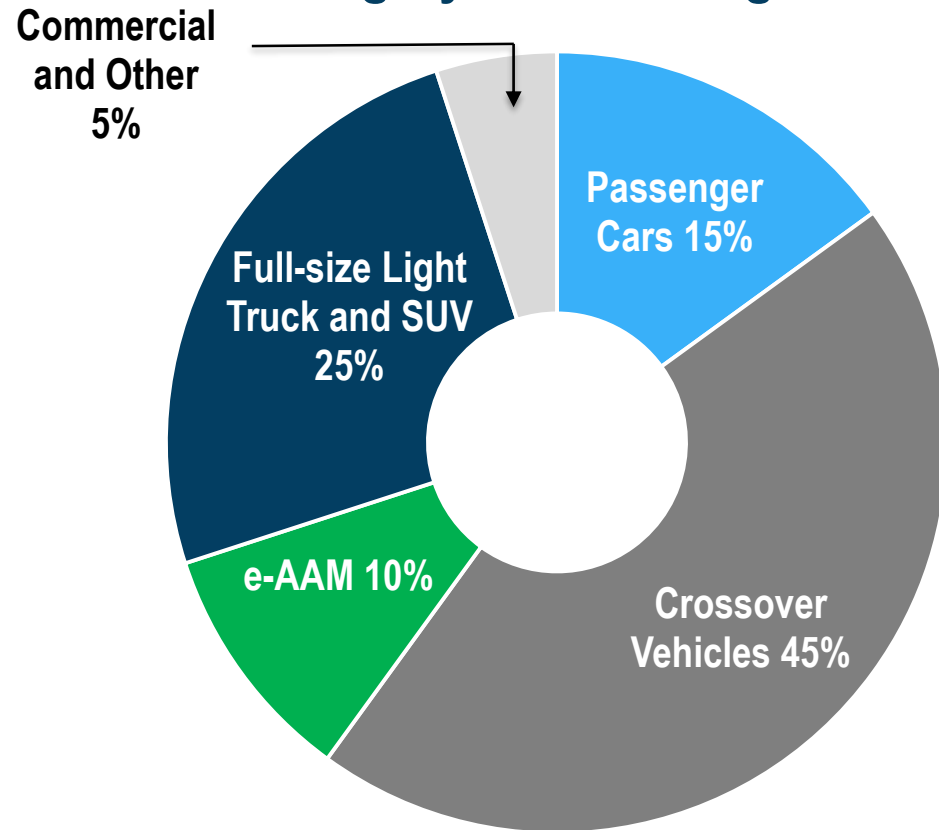

Backlog by Global Market

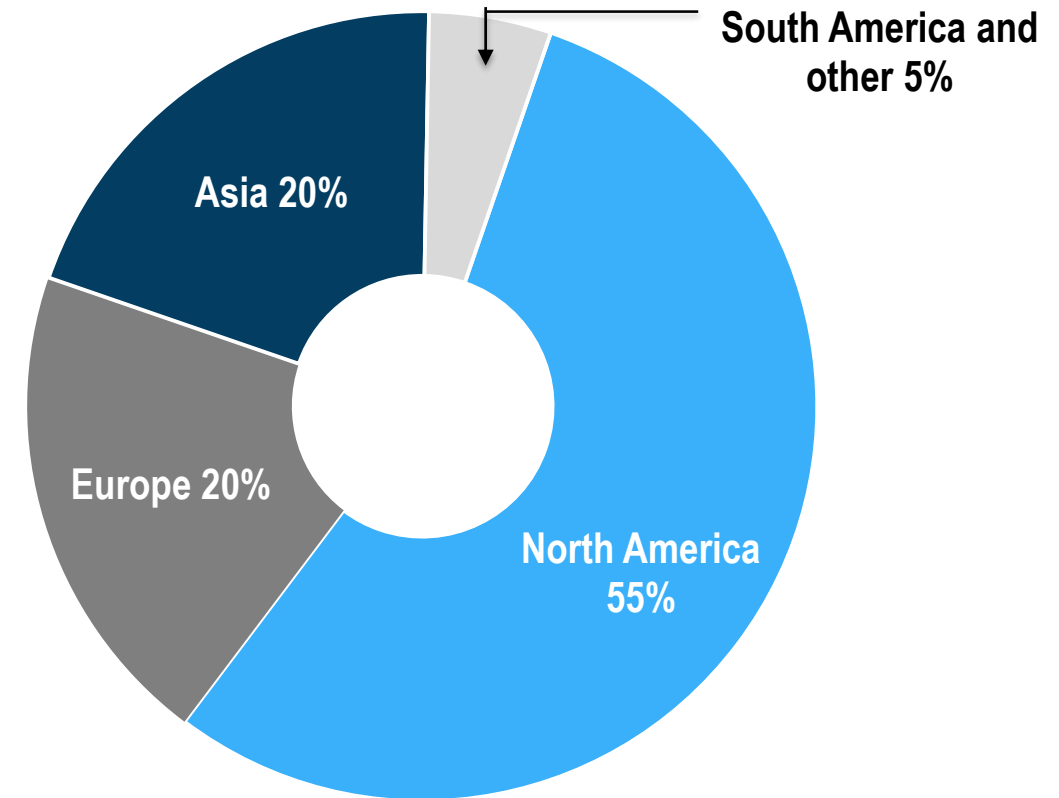

Our new business backlog continues to drive product, customer and geographic diversification

Net Impact of New Business Backlog

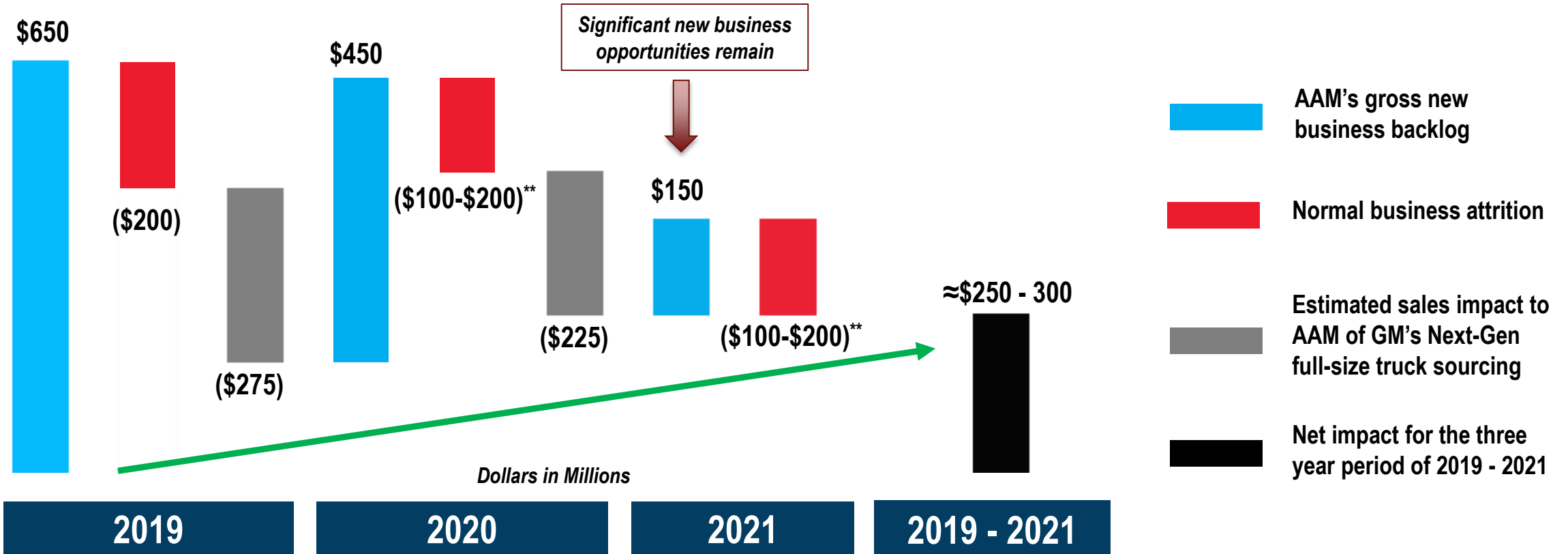

\$1.5 billion of quoting and emerging business opportunities would primarily impact 2021 and beyond

** Utilized the mid point for the range for charting purposes

As disclosed on January 15, 2019

Favorable Trends in Vehicle Mix



70%

of Total NA production

In 2018, light trucks, including SUVs, crossovers and vans, made up 70% of North American production and increased global market share

75%

AAM Revenue in 2018

AAM estimates approximately 3/4 of sales came from global light truck production in 2018

70%

of New Business Backlog

70% of AAM's new business backlog is related to light trucks, including nearly half related to crossover vehicles

All of AAM's business units are benefiting from the continued increase in light truck market share

Lightweighting and Fuel Efficiency



Down-sized Engines

AAM's Vibration Control Systems (VCS) are benefiting from the trend towards downsized engines and hybridization

Multi-speed Transmissions

Over the next several years, we expect a > 5% CAGR in transmissions with higher than six speeds – providing AAM with higher content-per-vehicle opportunities

Disconnecting All-Wheel Drive

AAM continues to win new business related to our Ecotrac disconnecting AWD and expects this technology to account for ≈\$800M of sales in 2020

AAM's technology leadership in advanced lightweighting and fuel efficiency solutions is driving profitable sales growth and business diversification

e-AAM Hybrid and Electric Driveline Systems™



KEY HIGHLIGHTS

- Highly integrated electric motor, gear reduction, & differential
- Power dense, low NVH, high efficiency design allows for easy integration for multiple vehicle platforms
- Broad spectrum of solutions - from value to high performance - to meet a wide range of vehicle, customer and geographic requirements
- First e-AAM program launched in 2018 at our Swidnica Manufacturing Facility in Poland
- Combined annual revenues for our two booked e-AAM programs are expected to be \$100 - \$200 million by 2021

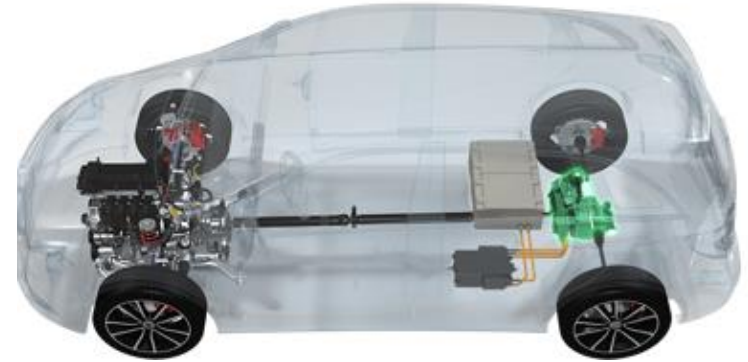

AAM P3 Rear e-Drive unit (Hybrid)
Launching in 2020

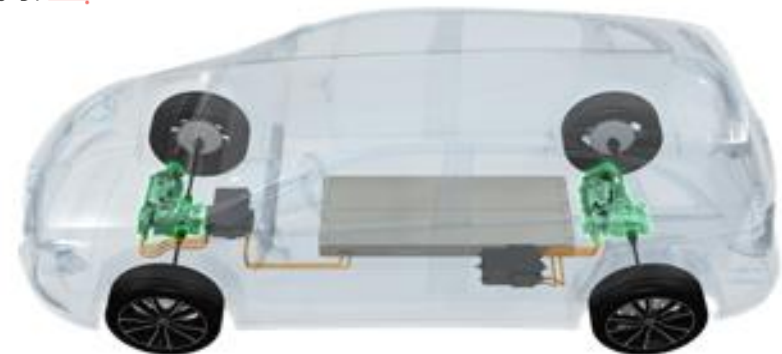

AAM P4 e-Drive units (e-AWD BEV)
Launched in 2018

Combined lifetime revenues of awarded e-AAM programs is estimated to be over \$1 billion

Future Electrification Opportunities



AAM's product portfolio supporting e-powertrains is driving potential new business globally

Gear Box Applications



ePowertrain Components



Vehicle Integration

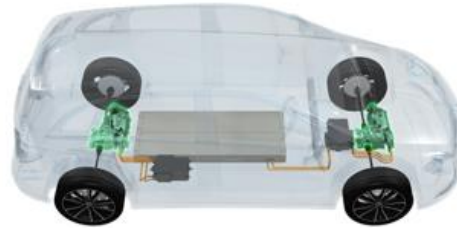

Integrated eFront Drive Units



Integrated eRear Drive Units



\$500M
Quoting and Emerging
New Business
Opportunities



Financial Targets

2019 Financial Outlook



2019 Financial Targets

Full Year Sales	\$7.3 - \$7.4 billion
Adjusted EBITDA*	\$1.2 - \$1.25 billion
Capital Expenditures	≈ 7% of sales
Adjusted Free Cash Flow*	\$350 - \$400 million

- Based on the anticipated launch schedule of our new business backlog, our assumption that the US SAAR* is between 16.5 – 17 million units and current metal market and foreign currency levels.
- Our 2019 financial targets for the full year contemplate customer downtime in preparation for critical program changeovers and related project expense. We expect this to have the greatest impact in the first quarter of 2019.
- We expect restructuring and acquisition-related payments to be between \$50 - \$60 million for the full year 2019.

2019 Sales Target Walk

(in millions)

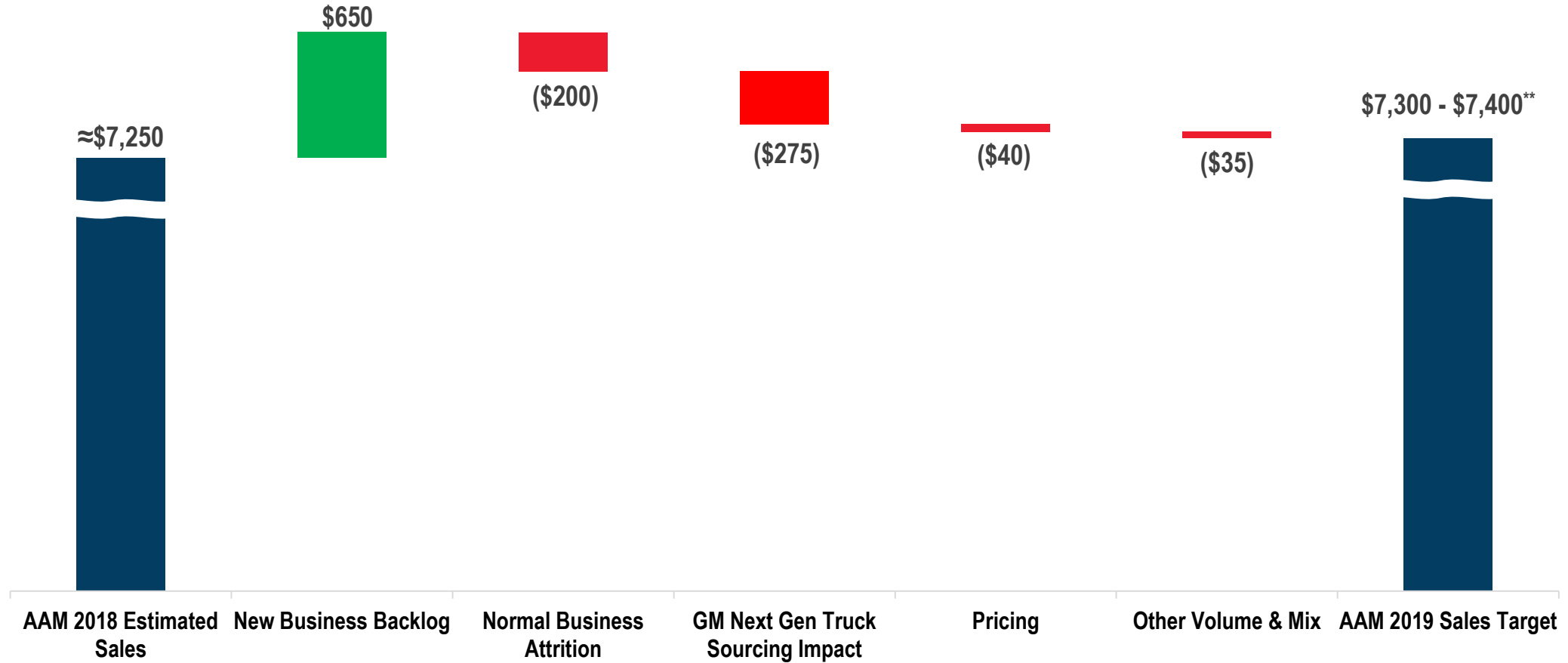

AAM expects sales growth in 2019

** Utilized the mid point for the range for charting purposes

2019 Adjusted EBITDA Target Walk

(dollars in millions)

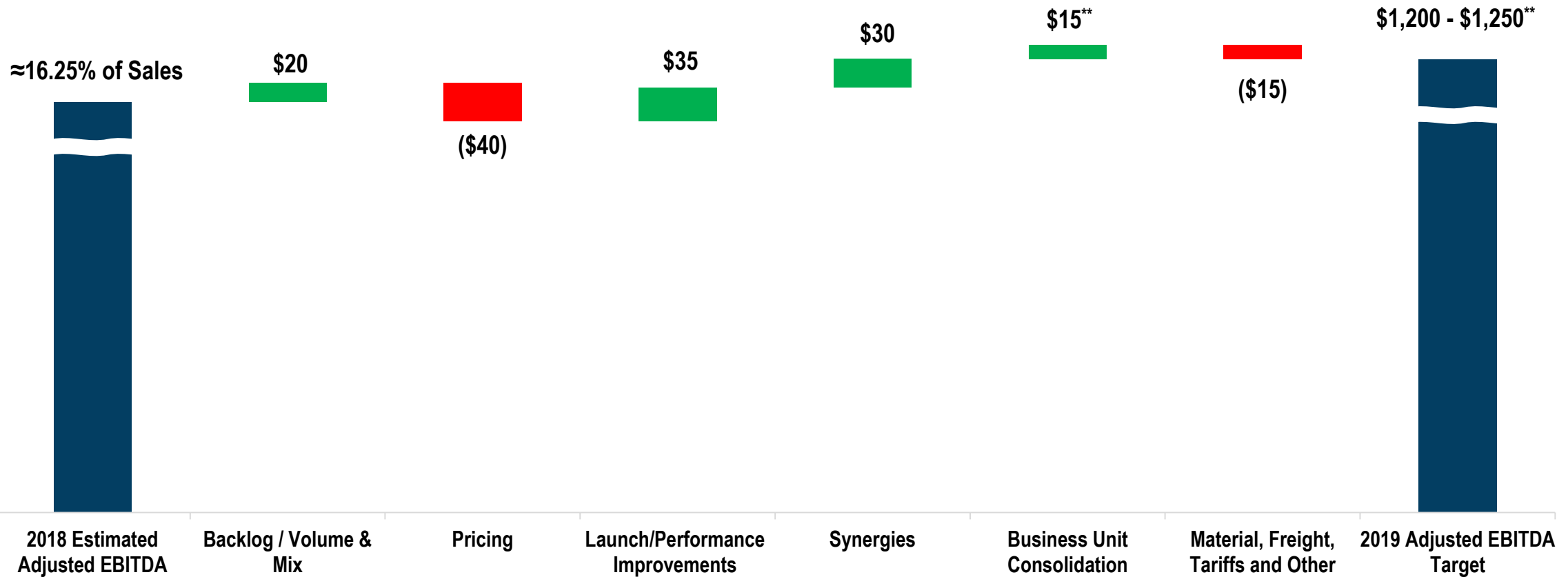

AAM expects to grow Adjusted EBITDA in 2019

* For definitions of Non-GAAP measures, please see the attached appendix ** Utilized the mid point for the range for charting purposes

2019 Profit Catalysts



Leaner, Stronger AAM

Business segment restructuring to create \$10 - \$20 million in annual cost savings

Continued Synergy Attainment

Benefiting from full-year run rate and further capacity optimization initiatives

New Business Contribution

\$650 million of new business backlog in 2019 will drive profitable sales growth

Performance Improvements

Resolution of supplier and launch issues allows for renewed focus on productivity and continuous improvement

AAM is focused on driving improved financial performance in 2019

Strong Cash Flow Generation

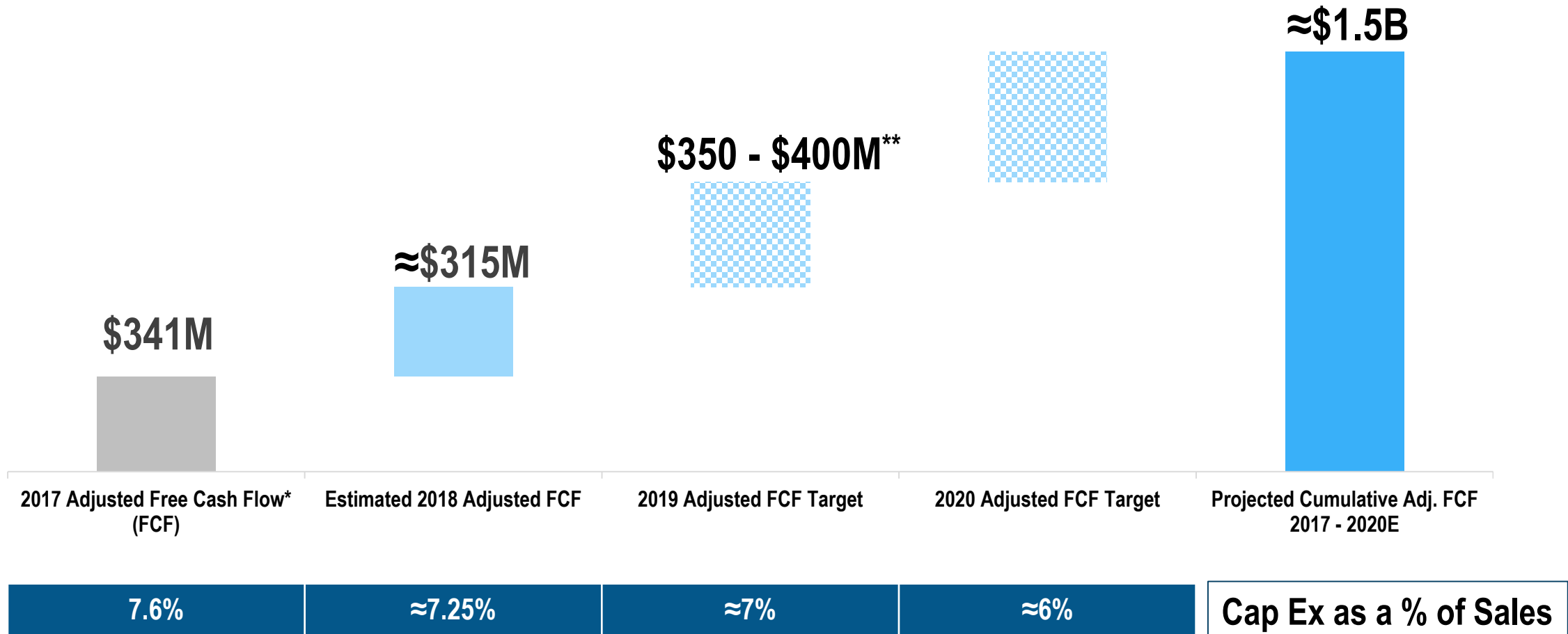

Strong cash flow potential and high free cash flow yield

* For definitions of Non-GAAP measures, please see attached appendix ** Utilized the mid point for the range for charting purposes

Cash Flow Breakeven



US SAAR (units in millions)

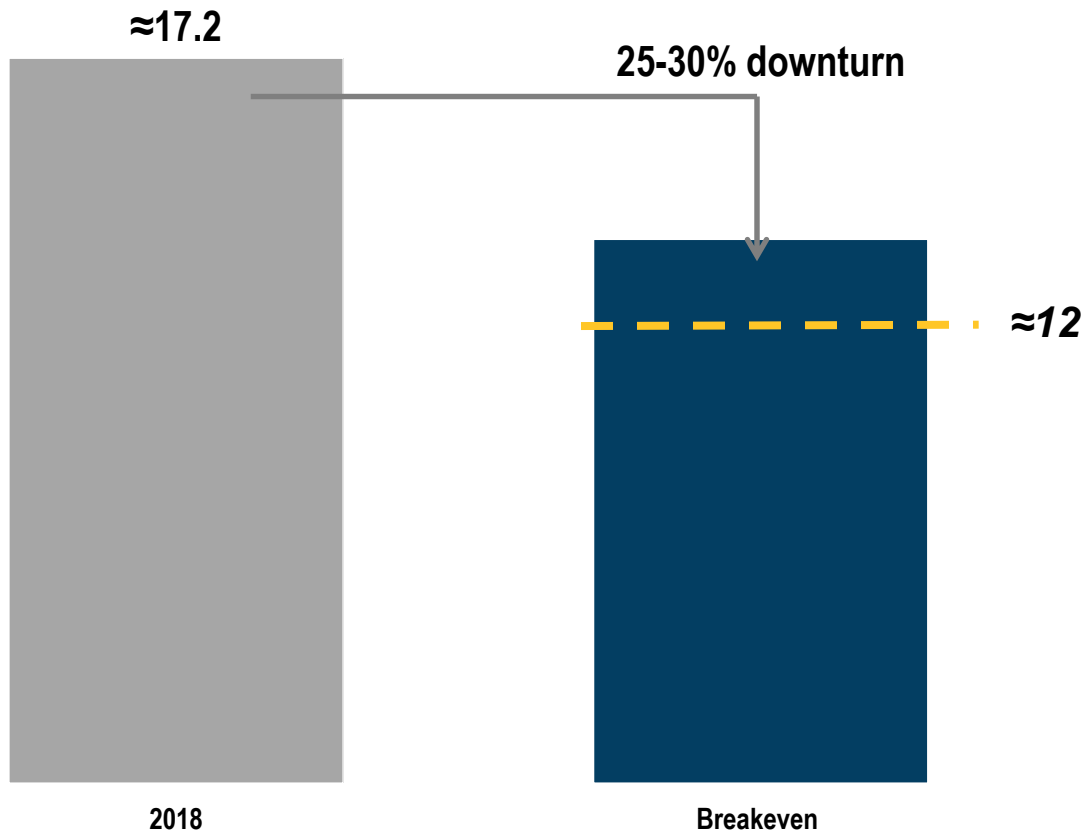

- Highly variable cost structure allows for flexibility during periods of lower volumes
- AAM has track record of reducing fixed costs through facility and labor efficiency initiatives during previous downside periods
- Multiple options available to manage to additional potential change in volumes, including SG&A, capital spending, R&D etc.
- Continued synergy attainment and productivity initiatives further reduce breakeven points

AAM has a flexible cost structure

Capital Allocation



Leverage Reduction	Organic Growth
<i>>\$400M of senior debt payments since the MPG acquisition and targeting Net Leverage Ratio of $\approx 2x$ by the end of 2020</i>	<i>Invest in R&D and continue organic growth with the appropriate returns</i>
Strategic	Shareholder Activity
<i>Focus on objectives of technology, portfolio positioning, diversification and growth</i>	<i>At the appropriate time, other options that may benefit our shareholders further</i>

Capital allocation aligned with AAM's strategic objectives

Why AAM?



SOLID FOUNDATIONAL BUSINESS

Concentrated in the strongest vehicle segments of light trucks, SUVs and crossovers

INNOVATIVE TECHNOLOGY LEADERSHIP

Focused on hybridization, electrification, lightweighting, fuel efficiency and performance

COMPELLING GROWTH AND DIVERSIFICATION

Driven by our new business backlog, innovative advanced technologies and global footprint

INDUSTRY LEADING PROFITABILITY

Fueled by powerful vertical integration, productivity initiatives and operational excellence

POWERFUL CASH GENERATOR

Strong free cash flow yield while funding investments in profitable growth opportunities

Potential for
Multiple
Expansion
and Share
Appreciation



Q&A



SUPPLEMENTAL DATA

Production and Sales Volume Assumptions



	2018	2019	2020
Global Light Vehicle Production	≈ 94.7M units	≈ 95M units	≈ 1 - 2% growth
North America Light Vehicle Production	≈ 17.0M units	≈ 16.5M – 17M units	≈ 16M – 17M units
US SAAR	≈ 17.2M units	≈ 16.5M – 17M units	≈ 16M – 17M units
Europe Light Vehicle Production	≈ 22.0M units	≈ Flat	≈ 1 - 2% growth
China Light Vehicle Production	≈ 27.3M units	≈ Flat	≈ 2 - 4% growth
North America Class 5-8 Commercial Vehicle Production	≈ 590k units	≈ 3 - 5% growth	≈ 5 - 10% decrease

Reconciliation of Non-GAAP Measures



In addition to the results reported in accordance with accounting principles generally accepted in the United States of America (GAAP) included within this presentation, we have provided certain information, which includes non-GAAP financial measures. Such information is reconciled to its closest GAAP measure in accordance with Securities and Exchange Commission rules and is included in the following slides.

Certain of the forward-looking financial measures included in this presentation (including our preliminary 2018 results and 2019 Financial Outlook) are provided on a non-GAAP basis. A reconciliation of certain non-GAAP forward-looking financial measures to the most directly comparable financial measures calculated and presented in accordance with GAAP is not practical given the difficulty of projecting event driven transactional and other non-core operating items and their related effects in any future period. The magnitude of these items, however, may be significant.

Supplemental Data



Free Cash Flow and Adjusted Free Cash Flow Reconciliation (\$ in millions)

	<u>2017 Actual</u>	<u>2018 Estimate</u>	<u>2019 Target</u>
Net cash provided by operating activities	\$ 647.0	\$ 770	\$ 810 - 860
Capital expenditures net of proceeds from the sale of property, plant and equipment	<u>(475.2)</u>	<u>(525)</u>	<u>(515)</u>
Free cash flow	171.8	245	295 - 345
Cash payments for restructuring and acquisition-related costs	109.3	70	55
Acquisition-related settlement of pre-existing accounts payable balances with acquired entities	35.2	-	-
Interest payments upon the settlement of acquired company debt	24.6	-	-
Adjusted free cash flow	<u>\$ 340.9</u>	<u>\$ 315</u>	<u>\$ 350 - 400</u>

Supplemental Data



EBITDA and Adjusted EBITDA We define EBITDA to be earnings before interest expense, income taxes, depreciation and amortization. Adjusted EBITDA is defined as EBITDA excluding the impact of restructuring and acquisition-related costs, debt refinancing and redemption costs, gain on sale of a business, goodwill impairments and non-recurring items. We believe that EBITDA and Adjusted EBITDA are meaningful measures of performance as they are commonly utilized by management and investors to analyze operating performance and entity valuation. Our management, the investment community and the banking institutions routinely use EBITDA and Adjusted EBITDA, together with other measures, to measure our operating performance relative to other Tier 1 automotive suppliers. We also use Segment Adjusted EBITDA as the measure of earnings to assess the performance of each segment and determine the resources to be allocated to the segments. EBITDA and Adjusted EBITDA should not be construed as income from operations, net income or cash flow from operating activities as determined under GAAP. Other companies may calculate EBITDA and Adjusted EBITDA differently.

Adjusted Earnings per Share We define Adjusted earnings per share to be diluted earnings per share excluding the impact of restructuring and acquisition-related costs, debt refinancing and redemption costs, gain on sale of a business, goodwill impairments and non-recurring items, including the tax effect thereon. We believe Adjusted earnings per share is a meaningful measure as it is commonly utilized by management and investors in assessing ongoing financial performance that provides improved comparability between periods through the exclusion of certain items that management believes are not indicative of core operating performance and which may obscure underlying business results and trends. Other companies may calculate Adjusted earnings per share differently.

Free Cash Flow and Adjusted Free Cash Flow We define free cash flow to be net cash provided by operating activities less capital expenditures net of proceeds from the sale of property, plant and equipment and government grants. Adjusted free cash flow is defined as free cash flow excluding the impact of cash payments for restructuring and acquisition-related costs, settlements of pre-existing accounts payable balances with acquired entities, and interest payments upon the settlement of acquired company debt. We believe free cash flow and Adjusted free cash flow are meaningful measures as they are commonly utilized by management and investors to assess our ability to generate cash flow from business operations to repay debt and return capital to our stockholders. Free cash flow and Adjusted free cash flow are also key metrics used in our calculation of incentive compensation. Other companies may calculate free cash flow and Adjusted free cash flow differently.

Net Debt and Net Leverage Ratio We define net debt to be total debt, net less cash and cash equivalents. We define Net Leverage Ratio to be net debt divided by the trailing 12 months of Adjusted EBITDA. We believe that Net Leverage Ratio is a meaningful measure of financial condition as it is commonly used by management, investors and creditors to assess capital structure risk. Other companies may calculate Net Leverage Ratio differently.

US SAAR We define US SAAR as the seasonally adjusted annual rate of light vehicle sales in the United States

CAGR Compound annual growth rate