



August 2022 Investor Presentation

BRINGING THE FUTURE
FASTER

Forward-Looking Statements



BRINGING THE FUTURE
FASTER

This presentation information contains forward-looking statements within the meaning of the Private Securities Litigation Reform Act of 1995. These forward-looking statements involve certain risks and uncertainties that could cause actual results to differ materially from those expressed or implied by these statements. These risks and uncertainties include factors detailed in the reports we file with the SEC, including those described under “Risk Factors” in our most recent Annual Report on Form 10-K and our Quarterly Reports on Form 10-Q. These forward-looking statements speak only as of the date of this communication. We expressly disclaim any obligation or undertaking to disseminate any updates or revisions to any forward-looking statement contained herein to reflect any change in our expectations with regard thereto or any change in events, conditions or circumstances on which any such statement is based.

It should also be noted that this information contains certain financial measures, including Adjusted EBITDA, Adjusted Earnings per Share, Adjusted Free Cash Flow, Net Leverage Ratio and Liquidity that are not required by, or presented in accordance with, accounting principles generally accepted in the United States, or GAAP. These measures are presented here to provide additional useful measurements to review our operations, provide transparency to investors and enable period-to-period comparability of financial performance. A description of non-GAAP financial measures that we use to evaluate our operations and financial performance, and reconciliation of these non-GAAP financial measures to the most directly comparable financial measures calculated and reported in accordance with GAAP, can be found in the appendix under “Reconciliation of Non-GAAP Measures.”

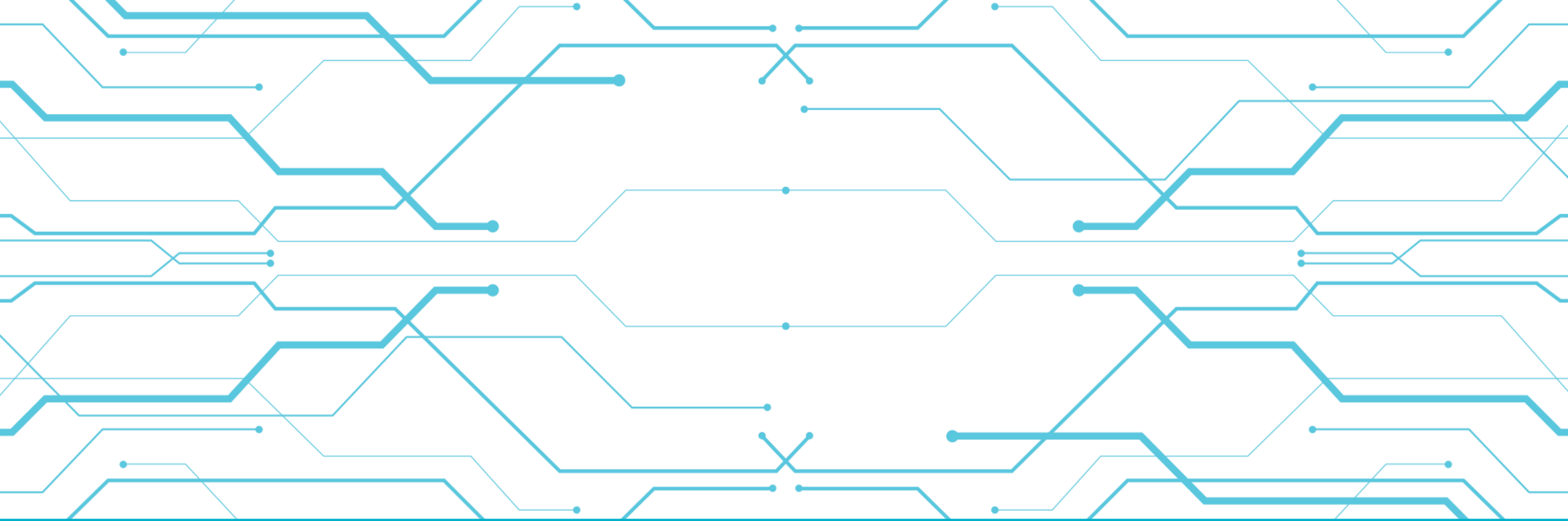

AAM Overview



BRINGING THE FUTURE
FASTER

AAM - Quick Facts



BRINGING THE FUTURE
FASTER

Global-leader in design, engineering and manufacturing of automotive propulsion systems and technologies to support electric, hybrid and ICE vehicles



\$5.2B 2021 Revenue

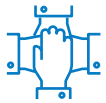

~20,000 Employees



18 Countries



Nearly 85 Locations



14 Global Engineering and Tech Centers



DRIVELINE

- One of the leaders in hybrid and electric driveline solutions
- A Global Leader in
 - Full-size pickup truck and SUV driveline systems
 - AWD systems for crossover vehicles
 - Damped gears, viscous dampers and rubber isolation pulleys
- Pioneer of disconnecting AWD Systems



METAL FORMING

- Leading automotive forger in the world
- A Global Leader in
 - Forged Gears & Shafts
 - CVT Pulleys
 - Powdered Metal Connecting Rods
 - Aluminum Valve Bodies
 - Machined Helical Gears
 - Differential Assemblies
- Strong position in electrified propulsion components

2Q 2022 AAM Financial Highlights



BRINGING THE FUTURE
FASTER

\$1.44B

Quarterly
Sales

\$195.1M

Second Quarter
Adjusted EBITDA

\$114.3M

Adjusted Free
Cash Flow

AAM Delivers Solid Results In A Difficult Operating Environment



Mercedes-AMG

AAM's electric driveline technology powers AMG's first plug-in hybrid electric (PHEV) model, the GT 63 S E PERFORMANCE. AAM supplies the performance car's rear drive unit, which was recently named a 2022 Automotive News PACE™ Award finalist.



Electrification

AAM awarded multiple contracts to supply major global OEMs with highly engineered electric components including gears for front and rear electric drive units.



Tekfor

Completed the acquisition of Tekfor Group in June. The acquisition provides significant synergy potential, diversifies AAM's geographic and customer sales mix and increases AAM's electrification product portfolio.

Updated 2022 Financial Outlook (as of August 5, 2022)



BRINGING THE FUTURE
FASTER

2022 Financial Targets

Full Year Sales	\$5.75 to \$5.95 billion
Adjusted EBITDA	\$790 to \$830 million
Adjusted Free Cash Flow	\$300 to \$350 million

- The updated financial outlook includes the Tekfor acquisition (which became effective on June 1) – cost synergies are on track for 2023
- These targets are based on North American light vehicle production range of 14.3 – 14.7 million units, current customer production and launch schedules and business environment
- Adjusted Free Cash Flow target assumes capital spending in the range of 3.5% - 4.0% of sales
- AAM expects restructuring and acquisition-related cash payments to be between \$30 and \$40 million

Gross New Business Backlog



BRINGING THE FUTURE
FASTER

\$700 Million Backlog

as disclosed on February 11, 2022

Backlog By Segment

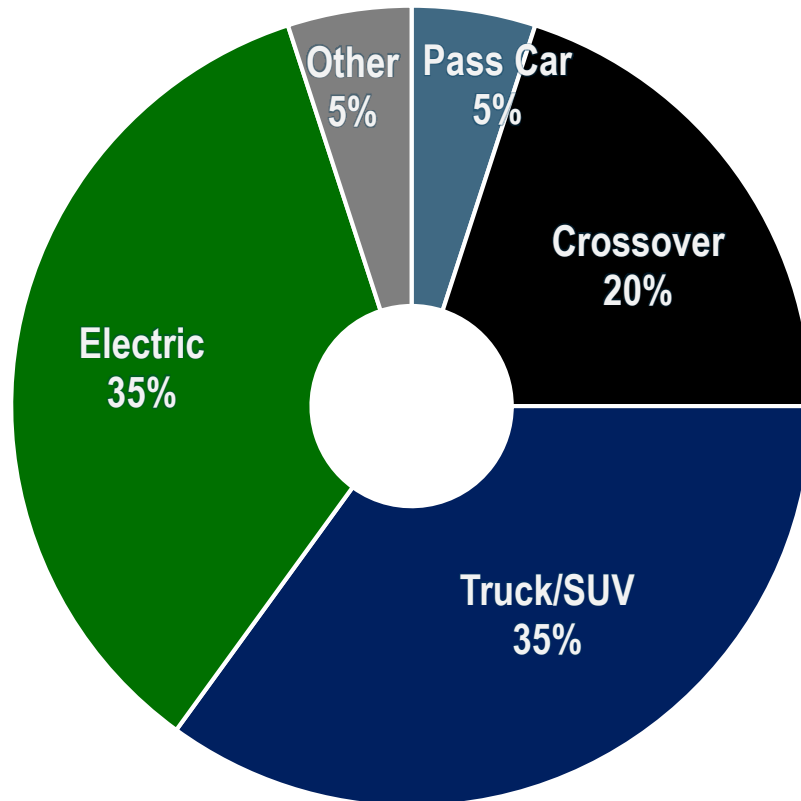

Backlog By Geography

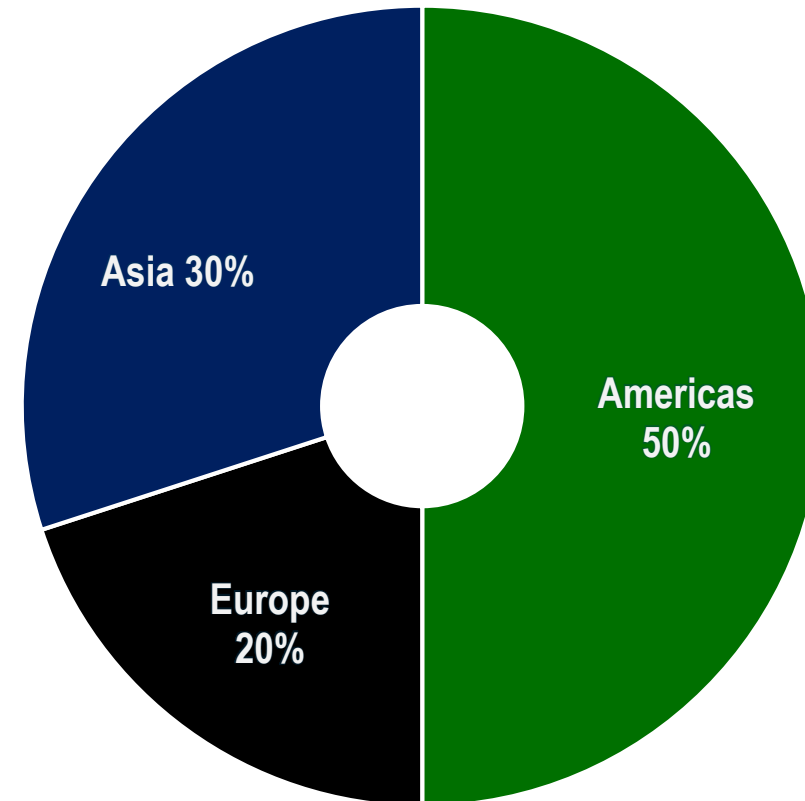

Electrification continues to be a growing portion of AAM's new business backlog

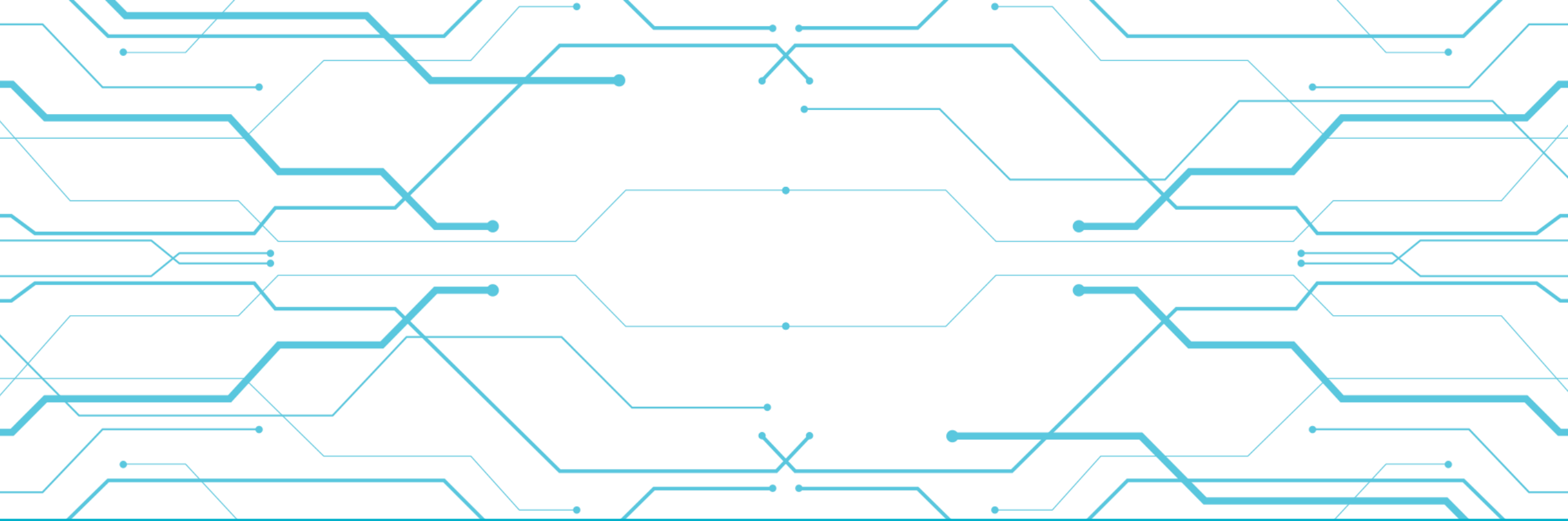

Environmental, Social, and Governance



BRINGING THE FUTURE
FASTER

Sustainability



BRINGING THE FUTURE
FASTER

2021 Report

- New sustainability report was published in April 2022.
- Our vision is to power a sustainable future while providing value to our stakeholders.
- The mission is to advance global mobility through innovative technologies and sustainable solutions.
- Our focus is to deliver power and build a safer, greener and sustainable future for our associates, customers, communities and the environment.



ENVIRONMENTAL

SOCIAL

PRODUCT

SUPPLY CHAIN

GOVERNANCE

Committed To Net Zero Carbon Emissions



BRINGING THE FUTURE
FASTER

New Targets

- We are focused on achieving profitable growth and doing so sustainably.
- We initially set goals to reduce GHG emissions, energy usage, and water consumption by 5% by the end of 2024.
- AAM achieved those goals ahead of schedule.
- We established new targets to guide AAM's global environmental sustainability initiatives.
- We applied for Science Based Targets initiative (SBTi) accreditation of our climate goals.



Scope 1, 2 & 3 Emissions

ACHIEVE NET ZERO CARBON BY 2040



Energy

100% RENEWABLE ENERGY SOURCING
IN THE U.S. BY 2025



Water

ZERO INCIDENTS OF WATER CONTAMINATION
AND WATER SCARCITY IN WATERSHEDS
WHERE WE OPERATE



Waste

ZERO-WASTE-TO-LANDFILL STATUS
FOR ALL FACILITIES BY 2035

ENVIRONMENTAL

SOCIAL

PRODUCT

SUPPLY CHAIN

GOVERNANCE

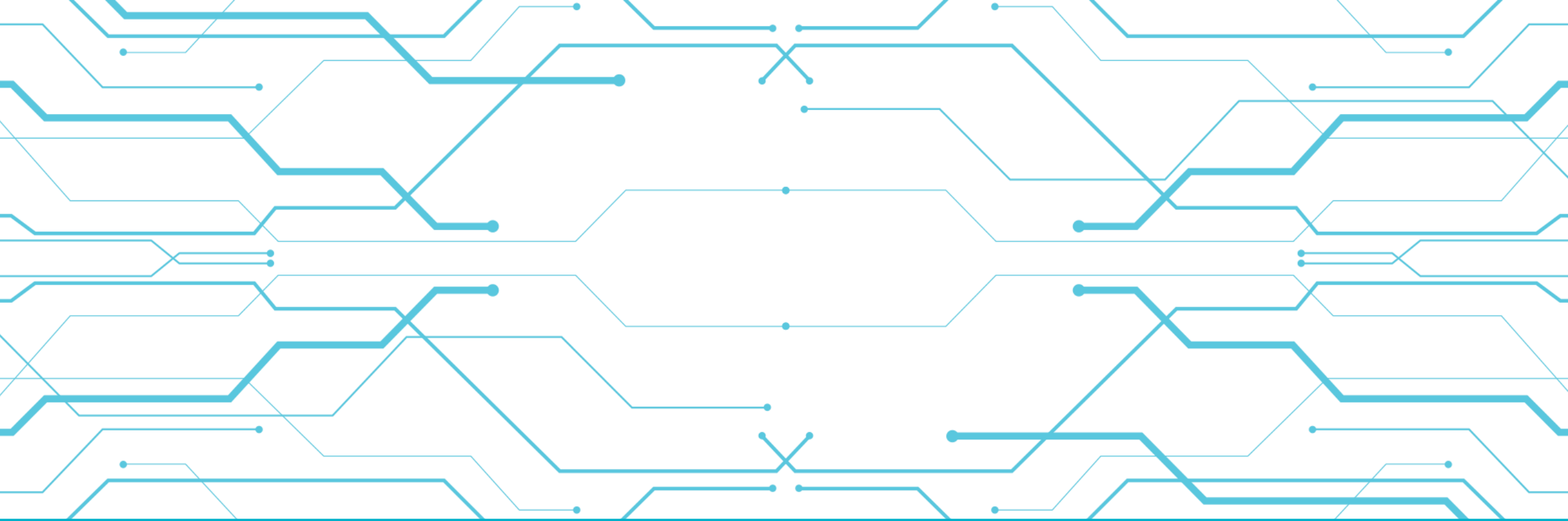

Electrification Product Technology



BRINGING THE FUTURE
FASTER

AAM Electrification History



BRINGING THE FUTURE
FASTER



2010

AAM & Saab establish e-AAM Driveline Systems Joint Venture



2017

AAM starts production to support Jaguar I-PACE



2020

AAM receives two PACE Awards



2021

Awarded NIO differential for next generation Electric Drive Units



2021

REE and AAM announce EDU production contract

2012

AAM acquires full ownership of e-AAM Driveline Systems



2020

AAM launches Baojun E300 program



2020

AAM secures multiple 3-in-1 programs in Asia



2021

AAM announces GMC Hummer EV differentials award



2022

AAM launched high-performance P3 program with Mercedes-AMG



AAM Electrification History

Key Business Awards in Electrification To Date



BRINGING THE FUTURE
FASTER

2-in-1 Electric Drive Units

Jaguar I-PACE (Europe)

- Two P4 Electric Drive Units
- 150 kW Power Level
- Power Dense Concentric Design
- Integrated Park Lock (Front EDU only)



Launched

Baojun E300 City Car (China)

- P4 Gearbox
- 40 kW Peak Power
- Offset Gearbox Design
- Integrated Park Lock

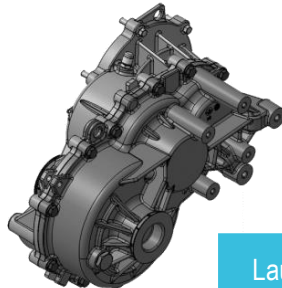

Launched

Mercedes-AMG GT 63 S E Performance

- P3 Hybrid Electric Drive Unit
- 150kW Peak Power
- 2-Speed Concentric Gearbox Design
- Integrated TracRite® eLSD



Launched

3-in-1 Electric Drive Units (Platform)

AAM / Inovance 3-in-1 eDrive (China)

- P4 Platform Electric Drive Units
- Scalable Power Level based on Application
- Offset Gearbox Design
- Optional Park Lock

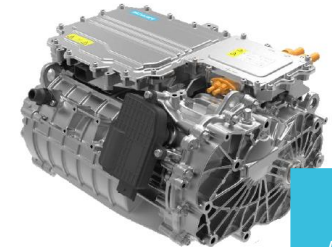

Multiple Programs Awarded & Launched

AAM Next Generation 3-in-1 eDrive

- Wheel End eDrive Units
- Compact Offset Gearbox Design
- High Power Density

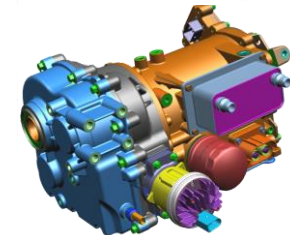

2024 Launch

Electric Drive Components

Electric Drive Unit Differentials/Components

- Multiple Chinese BEV Car & SUV Applications
- North American BEV Pick-up Truck Applications
- North American BEV Semi-Truck Application
- Multiple Europe BEV Light Vehicle Applications



Multiple Programs Awarded and Launched

AAM Electrification Global Footprint



BRINGING THE FUTURE
FASTER

Sales, Engineering, and Manufacturing Support in All Major Regions

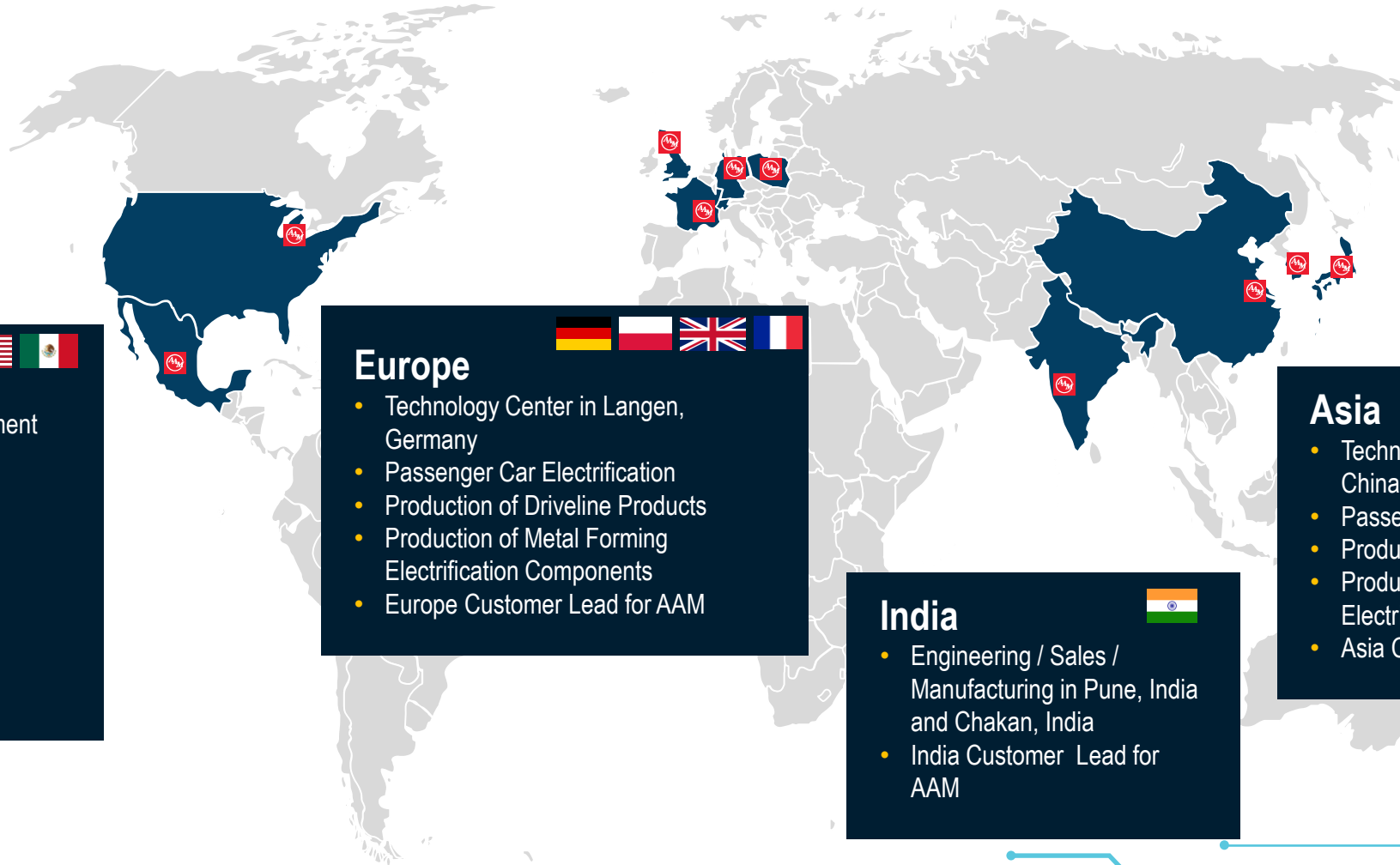

North America



- Advanced Technology Development Center in Detroit, Michigan
- Global Innovation Hub
- Global Core Technology
- Truck Electrification
- Production of Driveline Products
- Production of Metal Forming Electrification Components
- N.A. Customer Lead for AAM

Europe



- Technology Center in Langen, Germany
- Passenger Car Electrification
- Production of Driveline Products
- Production of Metal Forming Electrification Components
- Europe Customer Lead for AAM

India



- Engineering / Sales / Manufacturing in Pune, India and Chakan, India
- India Customer Lead for AAM

Asia



- Technology Center in Shanghai, China
- Passenger Car Electrification
- Production of Driveline Products
- Production of Metal Forming Electrification Components
- Asia Customer Lead for AAM

Significant Content Opportunity



BRINGING THE FUTURE
FASTER

Customer **In-House** Support

Components



Subsystems



Gearboxes

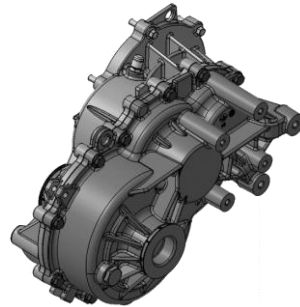

AAM CPV: Up to \$500

Customer **Outsourced** Support

Electric Drive Units



Vehicle Integration & Controls

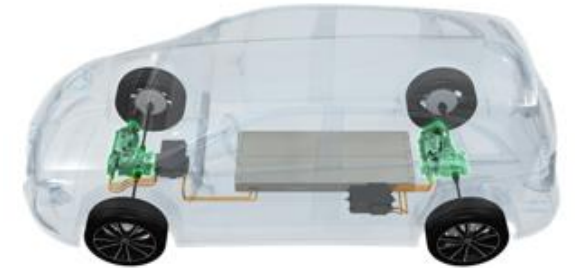

AAM CPV: Up to \$2,500+

AAM is Positioned to Support All OEM Sourcing Strategies

AAM and REE Partnership



BRINGING THE FUTURE
FASTER

- AAM announced in November 2021 it secured an agreement with REE to supply high-performance 3-in1 electric drive units (EDU).
- The REEcorner integrates critical vehicle components between the chassis and the wheel to deliver significant functional and economic advantages.
- AAM's compact EDUs enables REE's integration of these chassis systems into the REEcorner module.
- Development of EDU at AAM's Advanced Technology Development Center.
- Prototypes delivered at the end of 2021.
- Full production planned for 2024.



AAM Next Generation Electric Drive



BRINGING THE FUTURE
FASTER

Market Critical Attributes

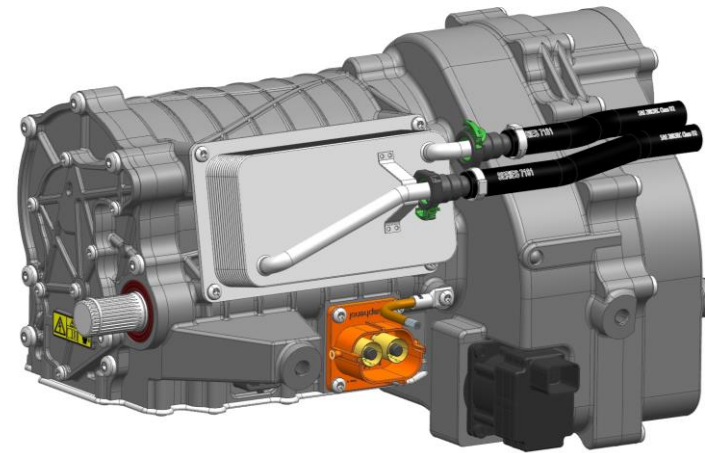
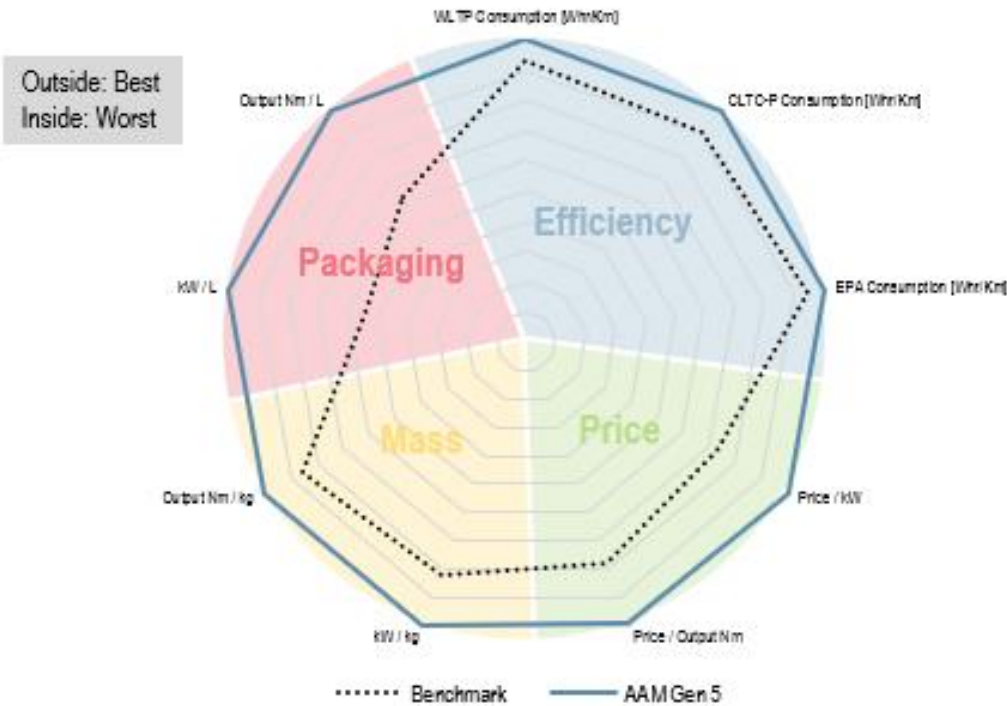

AAM Next Generation Electric Drive Units Deliver Compelling Performance

>10%

Improvement in
Mass Efficiency

>40%

Improvement in
Volumetric
Efficiency

>40%

Improvement in
Power Density

>10%

Reduced Power
Loss, More
Range

**Strong Value
Proposition**

**AAM's Next Generation Electric Drive exceeds
widely recognized industry benchmark in terms of critical EDU attributes**

Scalable & Modular Platform



BRINGING THE FUTURE
FASTER

AAM's Next Generation Scalable & Modular Electric Drive Units support numerous vehicle applications while optimizing capital and development costs

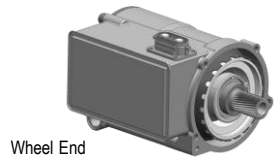

Wheel End

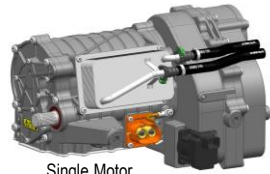

Single Motor

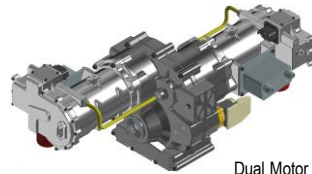

Dual Motor

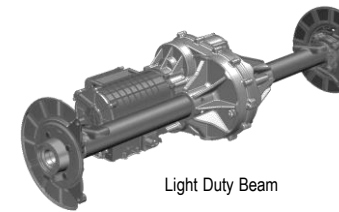

Light Duty Beam

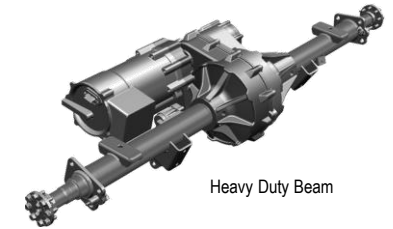

Heavy Duty Beam

Scalable Power Levels

Modular Motor Construction

Various EDU Architectures

Multiple Gear Ratios

Optional Torque
Vectoring & Disconnect



P3 HYBRID ARCHITECTURE

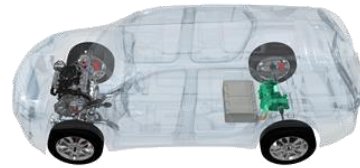

P4 SPLIT AXLE HYBRID ARCHITECTURE



P4 RWD ARCHITECTURE



P4 AWD MPV ARCHITECTURE

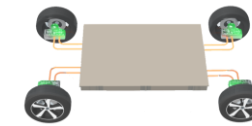

P4 AWD ARCHITECTURE



P4 FWD ARCHITECTURE

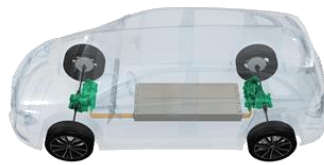

P4 AWD ARCHITECTURE



P4 4WD ARCHITECTURE



P4 4WD HD ARCHITECTURE

Denotes AAM EDU application

Electrification Summary



BRINGING THE FUTURE
FASTER

Proven electric drive systems design and integration capabilities in production

Well positioned to support all OEM sourcing strategies leveraging our strengths in software, integration, and manufacturing

Global reach and scalable product portfolio to serve all segments and major markets

Strategic partnerships to further accelerate the development and delivery of scalable, next-generation 3-in-1 electric drive systems

Highly integrated product technology resulting in improved power density, value, and efficiency

Next generation electric drive system is positioning us for continued profitable growth

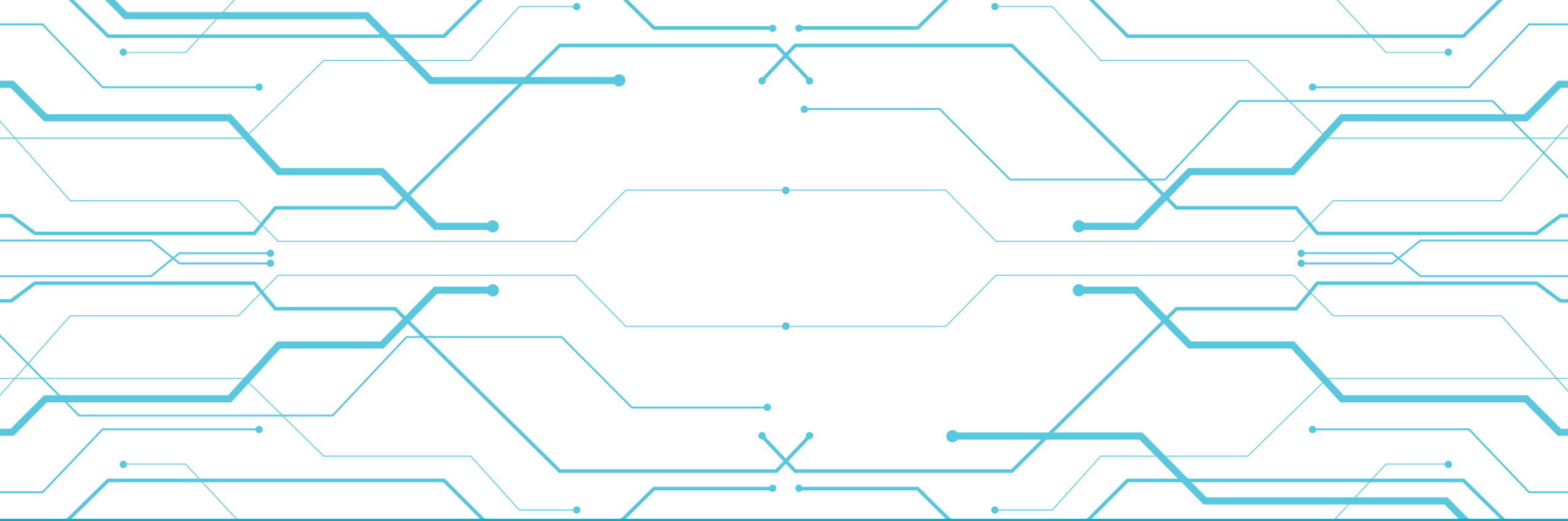

Supplemental Data



BRINGING THE FUTURE
FASTER

Reconciliation of Non-GAAP Measures



BRINGING THE FUTURE
FASTER

In addition to the results reported in accordance with accounting principles generally accepted in the United States of America (GAAP) included within this presentation, we have provided certain information, which includes non-GAAP financial measures. Such information is reconciled to its closest GAAP measure in accordance with Securities and Exchange Commission rules and is included in the following slides.

Certain of the forward-looking financial measures included in this earnings release are provided on a non-GAAP basis. A reconciliation of non-GAAP forward-looking financial measures to the most directly comparable forward-looking financial measures calculated and presented in accordance with GAAP has been provided. The amounts in these reconciliations are based on our current estimates and actual results may differ materially from these forward-looking estimates for many reasons, including potential event driven transactional and other non-core operating items and their related effects in any future period, the magnitude of which may be significant.



EBITDA and Adjusted EBITDA Reconciliation
(\$ in millions)

	Three Months Ended		Six Months Ended	
	June 30,		June 30,	
	2022	2021	2022	2021
Net income	\$ 22.9	\$ 16.0	\$ 23.9	\$ 54.6
Interest expense	42.7	49.9	87.4	101.0
Income tax expense	0.6	2.4	3.6	11.2
Depreciation and amortization	121.9	143.6	242.3	285.6
EBITDA	188.1	211.9	357.2	452.4
Restructuring and acquisition-related costs	9.6	15.9	18.5	33.4
Debt refinancing and redemption costs	0.2	1.3	5.8	2.4
Loss on sale of business	-	0.1	-	2.7
Unrealized loss on equity securities	3.7	-	21.7	-
Non-recurring items:				
Malvern fire charges, net of recoveries	0.1	(6.6)	(5.4)	(5.4)
Acquisition-related fair value inventory adjustment	5.0	-	5.0	-
Gain on bargain purchase of business	(11.6)	-	(11.6)	-
Adjusted EBITDA	\$ 195.1	\$ 222.6	\$ 391.2	\$ 485.5
Sales	1,438.3	1,283.3	2,874.5	2,708.4
as a % of net sales	13.6%	17.3%	13.6%	17.9%

Supplemental Data



BRINGING THE FUTURE
FASTER

EBITDA and Adjusted EBITDA for the Trailing Twelve Months Ended June 30, 2022 (\$ in millions)

	Quarter Ended				Trailing Twelve
	September 30, 2021	December 31, 2021	March 31, 2022	June 30, 2022	Months Ended June 30, 2022
Net income (loss)	\$ (2.4)	\$ (46.3)	\$ 1.0	\$ 22.9	\$ (24.8)
Interest expense	49.7	44.5	44.7	42.7	181.6
Income tax expense (benefit)	(13.6)	(2.3)	3.0	0.6	(12.3)
Depreciation and amortization	135.6	123.1	120.4	121.9	501.0
EBITDA	169.3	119.0	169.1	188.1	645.5
Restructuring and acquisition-related costs	7.4	8.6	8.9	9.6	34.5
Debt refinancing and redemption costs	31.6		5.6	0.2	37.4
Pension settlement		42.3			42.3
Unrealized loss (gain) on equity securities	(19.4)	(5.0)	18.0	3.7	(2.7)
Non-recurring items:					
Malvern fire charges, net of recoveries	(5.7)	(0.3)	(5.5)	0.1	(11.4)
Acquisition-related fair value inventory adjustment				5.0	5.0
Gain on bargain purchase of business				(11.6)	(11.6)
Adjusted EBITDA	\$ 183.2	\$ 164.6	\$ 196.1	\$ 195.1	\$ 739.0
Sales	1,213.1	1,235.1	1,436.2	1,438.3	5,322.7
as a % of net sales	15.1%	13.3%	13.7%	13.6%	13.9%



Adjusted Earnings Per Share Reconciliation

	Three Months Ended June 30,		Six Months Ended June 30,	
	2022	2021	2022	2021
Diluted earnings per share	\$ 0.19	\$ 0.13	\$ 0.20	\$ 0.46
Restructuring and acquisition-related costs	0.08	0.14	0.14	0.28
Debt refinancing and redemption costs	-	0.01	0.05	0.02
Loss on sale of business	-	-	-	0.02
Unrealized loss on equity securities	0.03	-	0.18	-
Accelerated depreciation*	-	0.09	-	0.19
Non-recurring items:				
Malvern fire charges, net of recoveries	-	(0.06)	(0.04)	(0.05)
Acquisition-related fair value inventory adjustment	0.04	-	0.04	-
Gain on bargain purchase of business	(0.09)	-	(0.09)	-
Tax effect of adjustments	(0.03)	(0.02)	(0.08)	(0.06)
Adjusted earnings per share	<u>\$ 0.22</u>	<u>\$ 0.29</u>	<u>\$ 0.40</u>	<u>\$ 0.86</u>

*Please refer to definition of Non-GAAP measures.



Free Cash Flow and Adjusted Free Cash Flow Reconciliation
(\$ in millions)

	Three Months Ended June 30,		Six Months Ended June 30,	
	2022	2021	2022	2021
Net cash provided by operating activities	\$ 146.7	\$ 167.1	\$ 215.2	\$ 346.2
Capital expenditures net of proceeds from the sale of property, plant and equipment	(42.6)	(41.2)	(67.0)	(80.8)
Free cash flow	104.1	125.9	148.2	265.4
Cash payments for restructuring and acquisition-related costs	8.1	15.5	16.5	38.9
Cash payments related to the Malvern fire, net of recoveries	2.1	(5.3)	3.5	5.9
Adjusted free cash flow	<u>\$ 114.3</u>	<u>\$ 136.1</u>	<u>\$ 168.2</u>	<u>\$ 310.2</u>



Net Debt and Net Leverage Ratio (\$ in millions)

	June 30, 2022
Current portion of long term debt	\$ 14.1
Long-term debt, net	3,034.8
Total debt, net	3,048.9
Less: Cash and cash equivalents	501.4
Net debt at end of period	2,547.5
Adjusted LTM EBITDA	\$ 739.0
Net Leverage Ratio	3.4x

Supplemental Data



BRINGING THE FUTURE
FASTER

Segment Financial Information (\$ in millions)

	Three Months Ended		Six Months Ended	
	June 30,		June 30,	
	2022	2021	2022	2021
Segment Sales				
Driveline	\$ 1,040.7	\$ 935.4	\$ 2,102.5	\$ 1,961.5
Metal Forming	512.9	440.1	994.7	929.4
Total Sales	1,553.6	1,375.5	3,097.2	2,890.9
Intersegment Sales	(115.3)	(92.2)	(222.7)	(182.5)
Net External Sales	<u>\$ 1,438.3</u>	<u>\$ 1,283.3</u>	<u>\$ 2,874.5</u>	<u>\$ 2,708.4</u>
Segment Adjusted EBITDA				
Driveline	\$ 141.4	\$ 151.3	\$ 273.9	\$ 321.8
Metal Forming	53.7	71.3	117.3	163.7
Total Segment Adjusted EBITDA	<u>\$ 195.1</u>	<u>\$ 222.6</u>	<u>\$ 391.2</u>	<u>\$ 485.5</u>

Supplemental Data



BRINGING THE FUTURE
FASTER

	Adjusted EBITDA	
	Low End	High End
	<i>(in millions)</i>	
Net income	\$ 55	\$ 85
Interest expense	175	175
Income tax expense	10	20
Depreciation and amortization	500	500
Full year 2022 targeted EBITDA	740	780
Restructuring and acquisition-related costs	35	35
Other	15	15
Full year 2022 targeted Adjusted EBITDA	<u>\$ 790</u>	<u>\$ 830</u>

	Adjusted Free Cash Flow	
	Low End	High End
	<i>(in millions)</i>	
Net cash provided by operating activities	\$ 480	\$ 530
Capital expenditures net of proceeds from the sale of property, plant and equipment	(215)	(215)
Full year 2022 targeted Free Cash Flow	265	315
Cash payments for restructuring and acquisition-related costs	35	35
Full year 2022 targeted Adjusted Free	<u>\$ 300</u>	<u>\$ 350</u>

Definition of Non-GAAP Measures



BRINGING THE FUTURE
FASTER

EBITDA and Adjusted EBITDA

We define EBITDA to be earnings before interest expense, income taxes, depreciation and amortization. Adjusted EBITDA is defined as EBITDA excluding the impact of restructuring and acquisition-related costs, debt refinancing and redemption costs, loss on sale of a business, impairment charges, pension settlements, unrealized gains or losses on equity securities and non-recurring items. We believe that EBITDA and Adjusted EBITDA are meaningful measures of performance as they are commonly utilized by management and investors to analyze operating performance and entity valuation. Our management, the investment community and the banking institutions routinely use EBITDA and Adjusted EBITDA, together with other measures, to measure our operating performance relative to other Tier 1 automotive suppliers. We also use Segment Adjusted EBITDA as the measure of earnings to assess the performance of each segment and determine the resources to be allocated to the segments. EBITDA and Adjusted EBITDA are also key metrics used in our calculation of incentive compensation. EBITDA and Adjusted EBITDA should not be construed as income from operations, net income or cash flow from operating activities as determined under GAAP. Other companies may calculate EBITDA and Adjusted EBITDA differently.

Adjusted Earnings Per Share

We define Adjusted earnings per share to be diluted earnings per share excluding the impact of restructuring and acquisition-related costs, debt refinancing and redemption costs, loss on sale of a business, impairment charges, pension settlements, certain accelerated depreciation, unrealized gains or losses on equity securities and non-recurring items, including the tax effect thereon. We believe Adjusted earnings per share is a meaningful measure as it is commonly utilized by management and investors in assessing ongoing financial performance that provides improved comparability between periods through the exclusion of certain items that management believes are not indicative of core operating performance and which may obscure underlying business results and trends. Other companies may calculate Adjusted earnings per share differently.

Free Cash Flow and Adjusted Free Cash Flow

We define free cash flow to be net cash provided by operating activities less capital expenditures net of proceeds from the sale of property, plant and equipment. Adjusted free cash flow is defined as free cash flow excluding the impact of cash payments for restructuring and acquisition-related costs and cash payments related to the Malvern fire, including payments for capital expenditures, net of recoveries. We believe free cash flow and Adjusted free cash flow are meaningful measures as they are commonly utilized by management and investors to assess our ability to generate cash flow from business operations to repay debt and return capital to our stockholders. Free cash flow and Adjusted free cash flow are also key metrics used in our calculation of incentive compensation. Other companies may calculate free cash flow and Adjusted free cash flow differently.

Net Debt and Net Leverage Ratio

We define net debt to be total debt, net less cash and cash equivalents. We define Net Leverage Ratio to be net debt divided by the trailing 12 months of Adjusted EBITDA. We believe that Net Leverage Ratio is a meaningful measure of financial condition as it is commonly used by management, investors and creditors to assess capital structure risk. Other companies may calculate Net Leverage Ratio differently.

Liquidity

We define Liquidity as cash on hand plus amounts available on our revolving credit facility and foreign credit facilities.

US SAAR

We define US SAAR as the seasonally adjusted annual rate of light vehicle sales in the United States.

Accelerated Depreciation

In the first quarter of 2021, one of our largest customers announced their intention to cease production operations in Brazil in 2021 as part of their restructuring actions. As such, we accelerated depreciation on certain property, plant and equipment beginning in the first quarter of 2021.

