



# August 2021 Investor Presentation

BRINGING THE FUTURE  
FASTER

# Forward-Looking Statements



BRINGING THE FUTURE  
FASTER

This supplemental information contains forward-looking statements within the meaning of the Private Securities Litigation Reform Act of 1995. These forward-looking statements involve certain risks and uncertainties that could cause actual results to differ materially from those expressed or implied by these statements. These risks and uncertainties include uncertainty around the duration and effects of the COVID-19 pandemic, and include factors detailed in the reports we file with the SEC, including those described under “Risk Factors” in our most recent Annual Report on Form 10-K and our Quarterly Reports on Form 10-Q. These forward-looking statements speak only as of the date of this communication. We expressly disclaim any obligation or undertaking to disseminate any updates or revisions to any forward-looking statement contained herein to reflect any change in our expectations with regard thereto or any change in events, conditions or circumstances on which any such statement is based.

It should also be noted that this information contains certain financial measures, including Adjusted EBITDA, Adjusted Earnings per Share, Adjusted Free Cash Flow, Net Leverage Ratio and Liquidity that are not required by, or presented in accordance with, accounting principles generally accepted in the United States, or GAAP. These measures are presented here to provide additional useful measurements to review our operations, provide transparency to investors and enable period-to-period comparability of financial performance. A description of non-GAAP financial measures that we use to evaluate our operations and financial performance, and reconciliation of these non-GAAP financial measures to the most directly comparable financial measures calculated and reported in accordance with GAAP, can be found in the appendix under “Reconciliation of Non-GAAP Measures”.



- **AAM Overview**
- **ESG Highlights**
- **Electrification Product Technology**

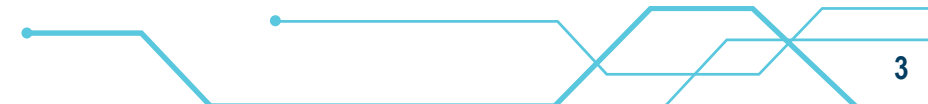

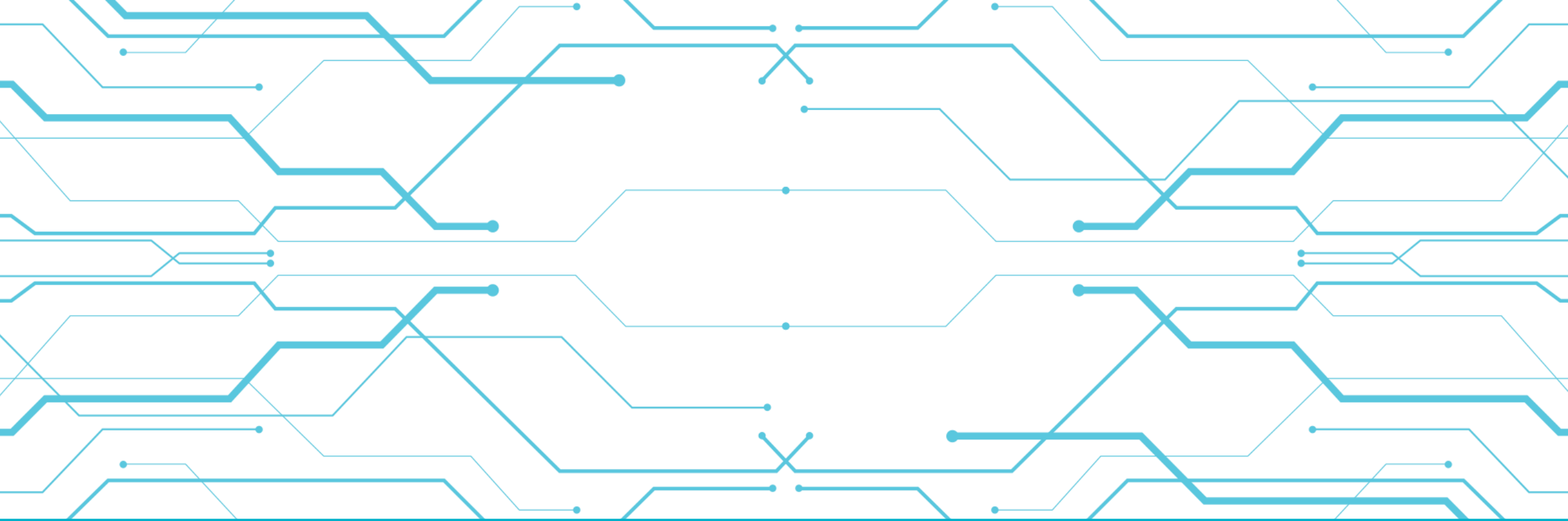

# AAM Overview



BRINGING THE FUTURE  
FASTER

# We Are AAM



BRINGING THE FUTURE  
**FASTER**



2020 SALES

**\$4.7B**

As a leading, global tier 1 automotive supplier, AAM designs, engineers and manufactures driveline and metal forming technologies that are making the next generation of vehicles smarter, lighter, safer and more efficient

AAM **delivers POWER** that moves the world through world-class quality, technology leadership and operational excellence

**Fortune 500**

**≈20,000**  
ASSOCIATES



**17**  
COUNTRIES

Nearly  
**80**  
LOCATIONS



Over  
**60**  
MANUFACTURING  
FACILITIES



**16**  
ENGINEERING CENTERS

# Business Units and Market Leadership



BRINGING THE FUTURE  
FASTER

## DRIVELINE



- **2020 Sales: \$3.6B**
- **A Global Leader in**
  - Full-size pickup truck and SUV driveline systems
  - AWD systems for crossover vehicles
  - Damped gears, viscous dampers and rubber isolation pulleys
- **Pioneer** of disconnecting AWD Systems
- One of the **leaders** in hybrid and electric driveline solutions

## METAL FORMING



- **2020 Sales: \$1.1B**
- **Largest automotive forger in the world**
- **A Global Leader in**
  - Powdered metal connecting rods
  - Differential gears
  - Axle shafts
  - Hypoid pinions
  - Ring gears
  - Transmission gears
  - CVT pulleys
  - Aluminum valve bodies

# 2Q 2021 AAM Financial Highlights



BRINGING THE FUTURE  
FASTER

**>\$1.28B**

Quarterly  
Sales

**\$223M**

Second Quarter  
Adj. EBITDA Margin of  
17.3%

**\$136M**

Adjusted Free  
Cash Flow

AAM Delivers Strong Results and Continues Debt Pay Down

# Business Update



BRINGING THE FUTURE  
FASTER



Secured business with NIO, a leading Chinese Electric Vehicle OEM, supplying differentials for its next generation ePowertrain program.



AAM has been named as sole-supplier of front and rear pickup axles for production at General Motor's Oshawa, Canada, facility.



AAM completed a small acquisition that specializes in powered metal technology which supports light weighting of components for improved fuel economy.





## 2021 Financial Targets

<b>Full Year Sales</b>	<b>\$5.3 - \$5.5 billion</b>
<b>Adjusted EBITDA</b>	<b>\$875 - \$925 million</b>
<b>Adjusted Free Cash Flow</b>	<b>\$350 - \$425 million</b>

- Customers prioritizing large truck and SUV output
- These targets are based on North American light vehicle production in the range of 14.4 – 14.6 million units; current and anticipated customer production and launch schedules; and the current business environment
- Adjusted Free Cash Flow target assumes capital spending of approximately 4.0% - 4.5% of sales
- AAM expects restructuring and acquisition-related cash payments to be between \$50 and \$65 million



# Environment, Social, and Governance



BRINGING THE FUTURE  
FASTER

# Sustainability Update



BRINGING THE FUTURE  
FASTER

In 2021, AAM published a comprehensive sustainability report with the reporting framework based on SASB, GRI, and TCFD standards



## TABLE OF CONTENTS

A Message from our Chairman & CEO	1
We are AAM	2
Sustainability Priority Topics	3
<b>Environmental</b>	4
Our Goals	5
AAM Environmental System E <sup>4</sup>	7
Environmental Initiatives	8
Carbon Disclosure Project Reporting	13
<b>Social</b>	14
Safety Management System S <sup>4</sup>	15
Diversity, Equity and Inclusion	17
AAM360	20
#TeamAAM in the Community	26
<b>Governance</b>	28
Sustainability Leadership	29
Ethics and Compliance	30
Supply Chain Compliance	31
Human Rights	33
Industry Associations	33
<b>Product</b>	34
Research and Development	35
Electric Drive Technology	35
AAM Quality System Q <sup>4</sup>	39
Appendix	
About this Report	A-1
GRI Index	A-3
SASB Index	A-11
TCFD Index	A-12

In a survey conducted by *Institutional Investor*, our Financially Material ESG Disclosures were ranked 1<sup>st</sup> out of 80+ nominated Small-cap Consumer companies\*

\*For our 2019 sustainability report

# Sustainability: Key Areas of Focus



BRINGING THE FUTURE  
FASTER

## ENVIRONMENTAL

Energy and Emissions  
Reduction

Reduce Water Use  
at Every Location

Reduce, Reuse, Recycle  
Industrial Materials

## SOCIAL

Associate Health, Safety  
and Wellness

Attract, Develop, Engage  
and Retain Diverse Talent

Partner with  
Global Communities

## GOVERNANCE

Ethical Business Practices  
and Training

Cascade and Verify  
Supplier Compliance

## PRODUCT

Investment  
in Technology

Product Quality  
and Safety

Our cross-functional team of subject matter experts considered Global Reporting Initiative (GRI) standards, industry-specific standards of the Sustainability Accounting Standards Board (SASB) and the United Nations Sustainable Development Goals to prioritize sustainability topics and develop performance indicators

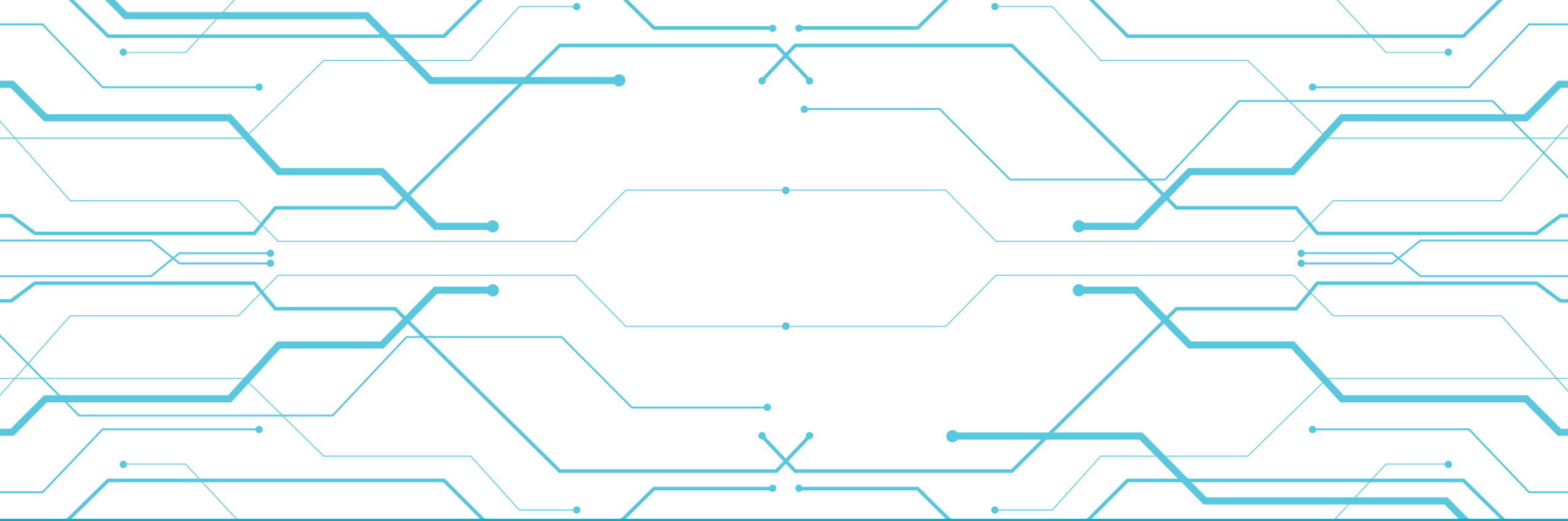

# Electrification Product Technology



BRINGING THE FUTURE  
FASTER



## AAM anticipates the addressable sourcing market at ~\$18-20 billion by 2030\*

- This includes electric drive units, subsystems and components
- We offer solutions for various OEM go-to-market strategies for electric vehicles
- Our technology is a key differentiator
- We expect the market to grow past 2030

### AAM's Competitive Advantage

Global Size  
& Scale

Operational  
Excellence

Technology  
Leadership

Broad Product  
Portfolio

Integration  
Experience

Technical  
Partnerships

*Note: Total global addressable markets is based on electric drive unit install rates across various propulsion types*

*\*Source: IHS and management estimates as of February 2021*

# Significant Content Opportunity



BRINGING THE FUTURE  
FASTER

## Customer **In-House** Support

Components



Subsystems



Gearboxes

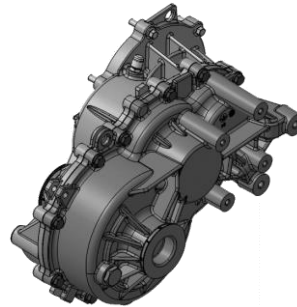

AAM CPV: Up to \$500

## Customer **Outsourced** Support

Electric Drive Units



Vehicle Integration & Controls

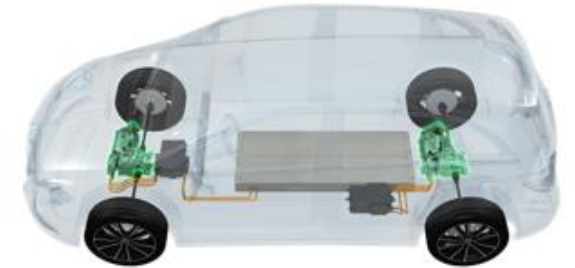

AAM CPV: Up to \$2,500+

**AAM is Positioned to Support All OEM Sourcing Strategies**

# AAM Electrification History

Key Business Awards in Electrification To Date



BRINGING THE FUTURE  
FASTER

## 2-in-1 Electric Drive Units

### Jaguar I-PACE (Europe)

- Two P4 Electric Drive Units
- 150 kW Power Level
- Power Dense Concentric Design
- Integrated Park Lock (Front EDU only)



Launched

### Baojun E300 City Car (China)

- P4 Gearbox
- 40 kW Peak Power
- Offset Gearbox Design
- Integrated Park Lock

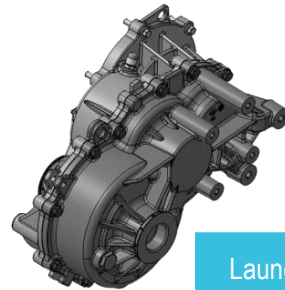

Launched

### High Performance Luxury OEM (Europe)

- P3 Hybrid Electric Drive Unit
- 160kW Peak Power
- 2-speed Concentric Gearbox Design
- Integrated TracRite® eLSD

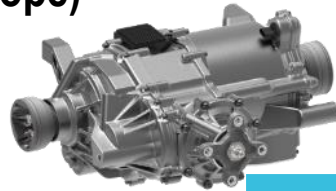

2021 Launch

## 3-in-1 Electric Drive Units (Platform)

### AAM / Inovance 3-in-1 eDrive (China)

- P4 Platform Electric Drive Units
- Scalable Power Level based on Application
- Offset Gearbox Design
- Optional Park Lock

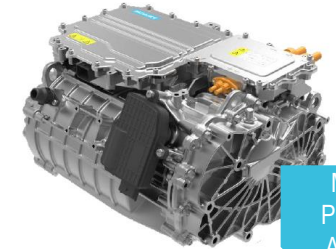

Multiple Programs Awarded

## Electric Drive Components

### Electronic Limited Slip Differential

- North American BEV Pick-up Truck Application

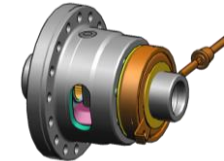

Awarded

### Commercial Vehicle Differential

- North American BEV Semi-Truck Application

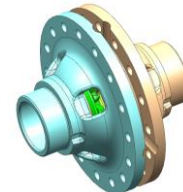

Awarded

### Planetary Geartrain

- European BEV Passenger Car Application



Awarded



# AAM – REE Joint Development Agreement



BRINGING THE FUTURE  
FASTER

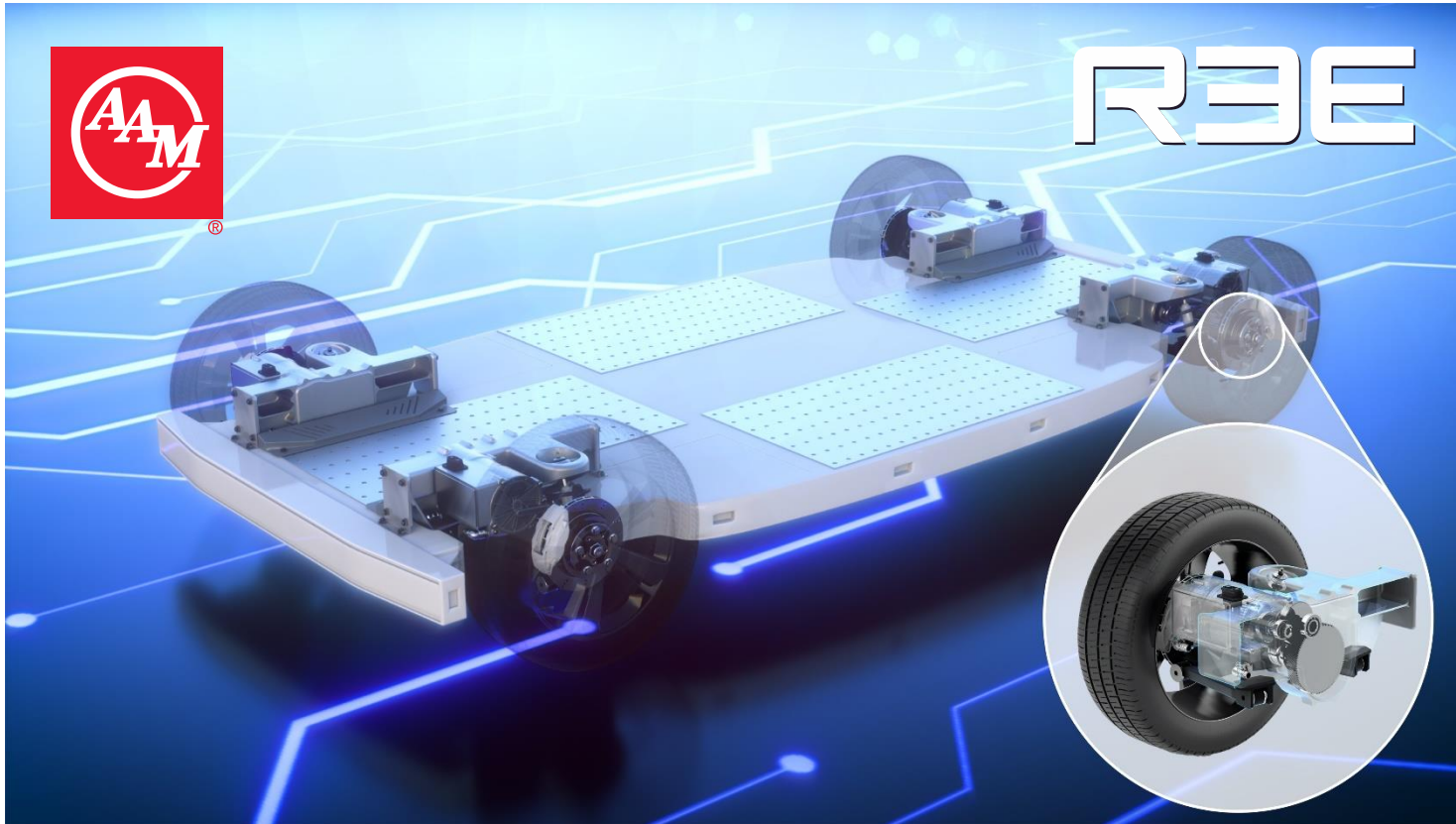

Development is expected to occur at AAM's Advanced Technology and Development Center in Detroit with delivery of prototypes planned by the end of 2021

- AAM and REE intend to incorporate AAM's next generation of **high-speed electric drive units**, which feature a **fully integrated high-speed motor and inverter**, into REE's highly modular and disruptive REEcorner™ technology.
- The REEcorner integrates critical vehicle chassis systems (propulsion, steering, braking, suspension, and controls) into a module that sits in-between the vehicle sub-frame and wheel to provide **additional space for battery storage, enabling greater vehicle range**.
- AAM's **electric drive technology** enables REE's integration of these chassis systems into the REEcorner module based on its **industry leading power density and compact design**.

## ■ Inovance Overview

- Leading Independent Traction Inverter Supplier in China
- Portfolio of Electric Propulsion Products  
Inverters, Motors, DC/DC Converters, On-Board Chargers, 3-in-1 Electric Drive Units
- Strong Technical Team with Full Development Capability
- Competitive and Vertically Integrated Manufacturing Footprint

## ■ Multiple Programs Awarded via Partnership

**INOVANCE**  
Automotive

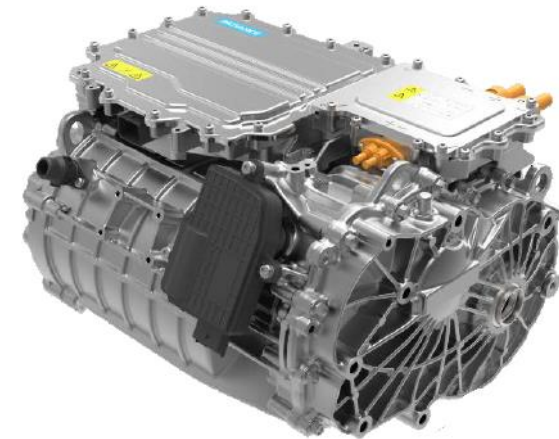

**Partnership Accelerates Development of Next Generation Fully Integrated 3-in-1 EDUs and Increased Access to the largest BEV Market**

# AAM Next Generation Electric Drive



BRINGING THE FUTURE  
FASTER

## Market Critical Attributes

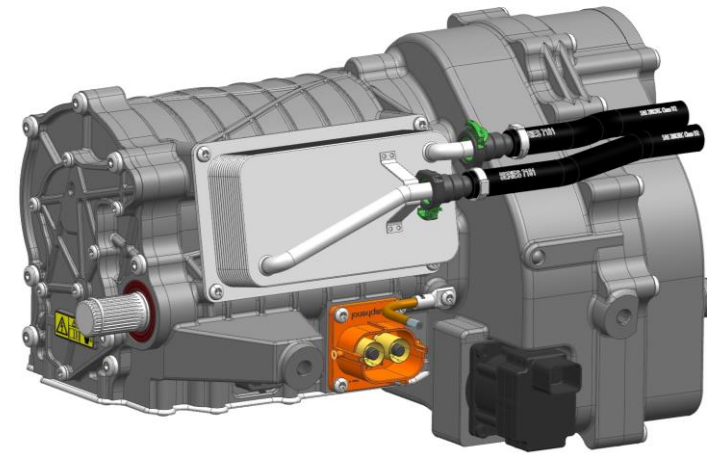
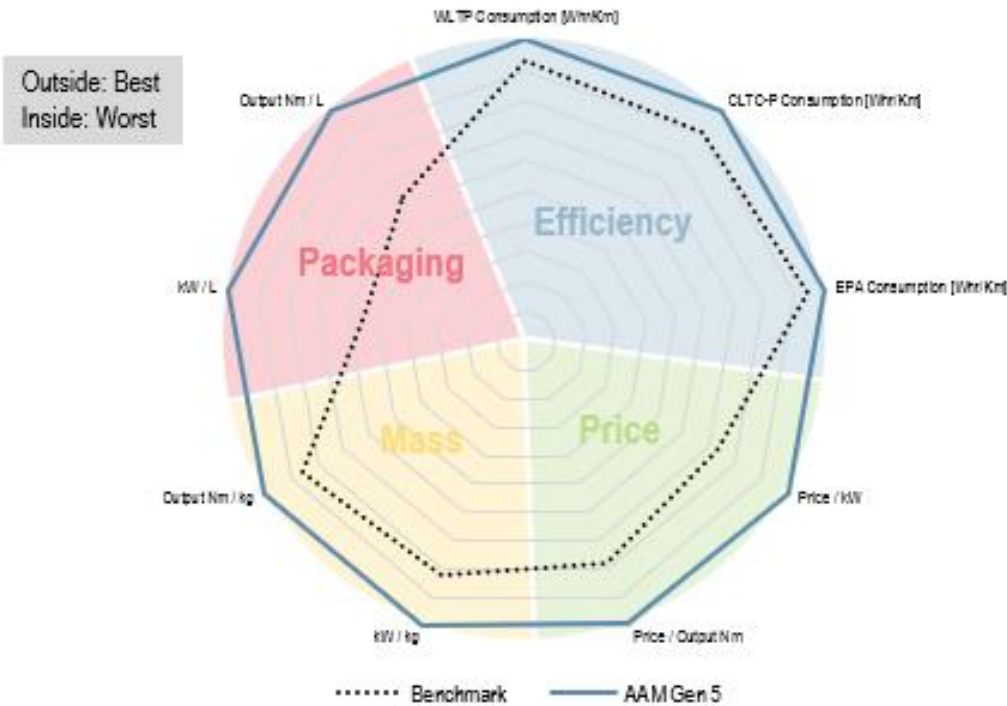

## AAM Next Generation Electric Drive Units Deliver Compelling Performance

>10%

Improvement in  
Mass Efficiency

>40%

Improvement in  
Volumetric  
Efficiency

>40%

Improvement in  
Power Density

>10%

Reduced Power  
Loss, More  
Range

Strong Value  
Proposition

**AAM's Next Generation Electric Drive exceeds widely recognized industry benchmark in terms of critical EDU attributes**

# Scalable & Modular Platform



BRINGING THE FUTURE  
FASTER

AAM's Next Generation Scalable & Modular Electric Drive Units support numerous vehicle applications while optimizing capital and development costs

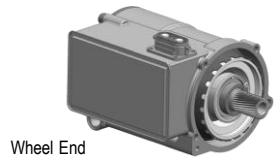

Wheel End

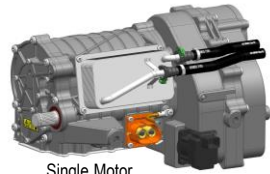

Single Motor

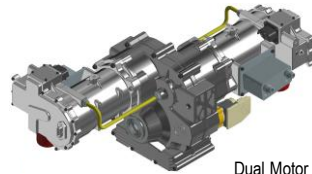

Dual Motor

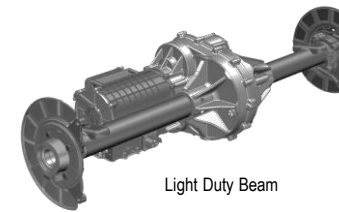

Light Duty Beam

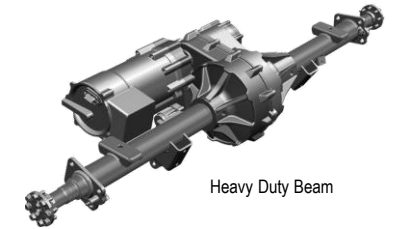

Heavy Duty Beam

Scalable Power Levels

Modular Motor Construction

Various EDU Architectures

Multiple Gear Ratios

Optional Torque  
Vectoring & Disconnect



P3 HYBRID ARCHITECTURE

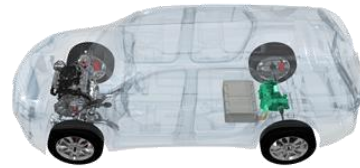

P4 SPLIT AXLE HYBRID ARCHITECTURE



P4 RWD ARCHITECTURE



P4 AWD MPV ARCHITECTURE

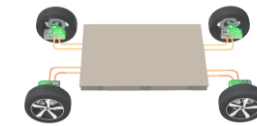

P4 AWD ARCHITECTURE



P4 FWD ARCHITECTURE

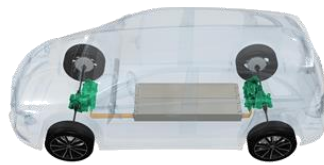

P4 AWD ARCHITECTURE



P4 4WD ARCHITECTURE

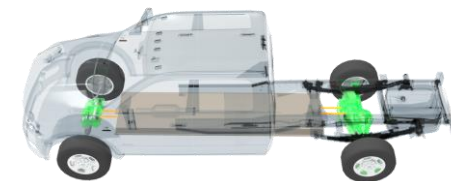

P4 4WD HD ARCHITECTURE

Denotes AAM EDU application

# Electrification Summary



BRINGING THE FUTURE  
FASTER

**Proven electric drive systems design and integration capabilities in production**

**Well positioned to support all OEM sourcing strategies leveraging our strengths in software, integration, and manufacturing**

**Global reach and scalable product portfolio to serve all segments and major markets**

**Strategic partnerships to further accelerate the development and delivery of scalable, next-generation 3-in-1 electric drive systems**

**Highly integrated product technology resulting in improved power density, value, and efficiency**

**Next generation electric drive system is positioning us for continued profitable growth**

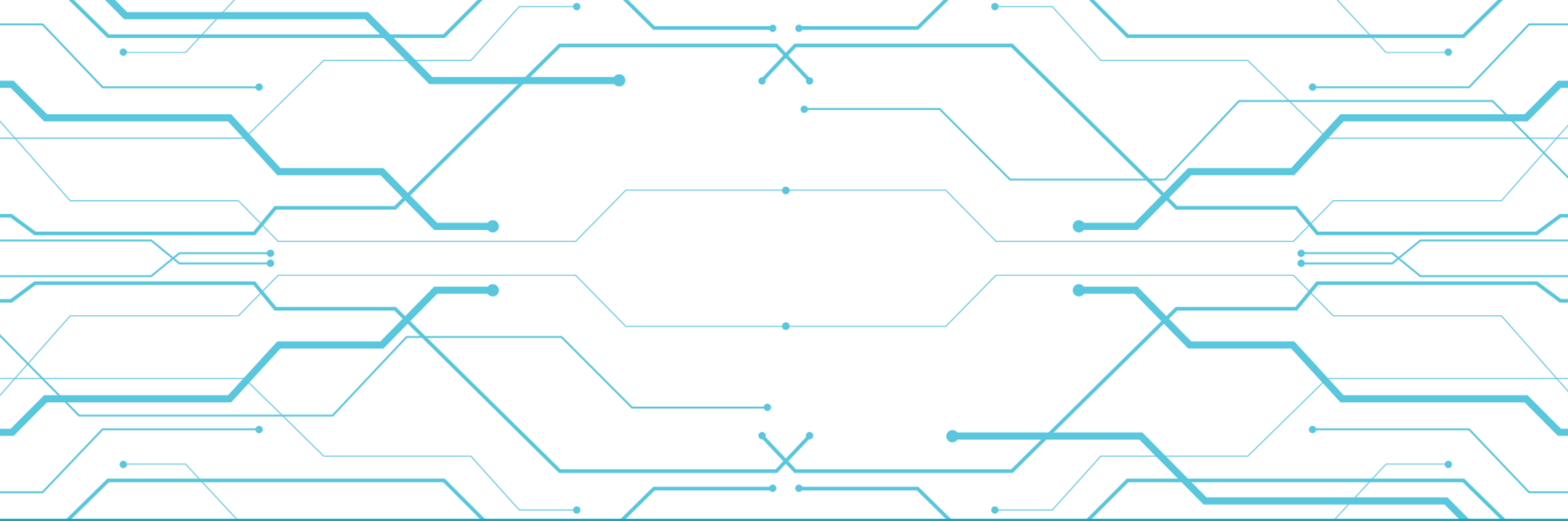

# Supplemental Data



BRINGING THE FUTURE  
FASTER

# Reconciliation of Non-GAAP Measures



BRINGING THE FUTURE  
FASTER

In addition to the results reported in accordance with accounting principles generally accepted in the United States of America (GAAP) included within this presentation, we have provided certain information, which includes non-GAAP financial measures. Such information is reconciled to its closest GAAP measure in accordance with Securities and Exchange Commission rules and is included in the following slides.

Certain of the forward-looking financial measures included in this earnings release are provided on a non-GAAP basis. A reconciliation of non-GAAP forward-looking financial measures to the most directly comparable forward-looking financial measures calculated and presented in accordance with GAAP has been provided. The amounts in these reconciliations are based on our current estimates and actual results may differ materially from these forward-looking estimates for many reasons, including potential event driven transactional and other non-core operating items and their related effects in any future period, the magnitude of which may be significant.

# Supplemental Data



BRINGING THE FUTURE  
FASTER

## EBITDA and Adjusted EBITDA Reconciliation (\$ in millions)

	Three Months Ended June 30,		Six Months Ended June 30,	
	2021	2020	2021	2020
Net income (loss)	\$ 16.0	\$ (213.2)	\$ 54.6	\$ (714.4)
Interest expense	49.9	54.6	101.0	106.1
Income tax expense (benefit)	2.4	(43.9)	11.2	(40.6)
Depreciation and amortization	143.6	139.1	285.6	268.7
EBITDA	211.9	(63.4)	452.4	(380.2)
Restructuring and acquisition-related costs	15.9	11.3	33.4	28.9
Debt refinancing and redemption costs	1.3	0.0	2.4	1.5
Impairment charges	0.0	0.0	0.0	510.0
Loss on sale of business	0.1	0.0	2.7	1.0
Non-recurring items:				
Malvern fire charges, net of recoveries	(6.6)	0.0	(5.4)	0.0
Adjusted EBITDA	\$ 222.6	\$ (52.1)	\$ 485.5	\$ 161.2
Sales	1,283.3	515.3	2,708.4	1,858.8
as a % of net sales	17.3%	-10.1%	17.9%	8.7%



# Supplemental Data



BRINGING THE FUTURE  
FASTER

## EBITDA and Adjusted EBITDA for the Trailing Twelve Months Ended June 30, 2021 (\$ in millions)

	Quarter Ended				Trailing Twelve Months Ended
	September 30, 2020	December 31, 2020	March 31, 2021	June 30, 2021	June 30, 2021
Net income	\$ 117.2	\$ 36.1	\$ 38.6	\$ 16.0	\$ 207.9
Interest expense	53.9	52.3	51.1	49.9	207.2
Income tax expense (benefit)	(22.5)	13.9	8.8	2.4	2.6
Depreciation and amortization	125.0	128.2	142.0	143.6	538.8
EBITDA	273.6	230.5	240.5	211.9	956.5
Restructuring and acquisition-related costs	9.7	28.6	17.5	15.9	71.7
Debt refinancing and redemption costs	5.2	1.2	1.1	1.3	8.8
Pension settlement		0.5			0.5
Loss on sale of business	-	-	2.6	0.1	2.7
Non-recurring items:					
Malvern fire charges, net of recoveries	8.6	0.7	1.2	(6.6)	3.9
Adjusted EBITDA	\$ 297.1	\$ 261.5	\$ 262.9	\$ 222.6	\$ 1,044.1
Sales	1,414.1	1,437.9	1,425.1	1,283.3	5,560.4
as a % of net sales	21.0%	18.2%	18.4%	17.3%	18.8%

# Supplemental Data



BRINGING THE FUTURE  
FASTER

## Adjusted Earnings (Loss) Per Share Reconciliation

	Three Months Ended June 30,		Six Months Ended June 30,	
	2021	2020	2021	2020
Diluted earnings (loss) per share	\$ 0.13	\$ (1.88)	\$ 0.46	\$ (6.33)
Restructuring and acquisition-related costs	0.14	0.10	0.28	0.26
Debt refinancing and redemption costs	0.01	-	0.02	0.01
Loss on sale of business	-	-	0.02	0.01
Impairment charges	-	-	-	4.52
Accelerated depreciation*	0.09	0.08	0.19	0.14
Non-recurring items:				
Malvern fire charges, net of recoveries	(0.06)	-	(0.05)	-
Tax adjustments related to the CARES Act	-	-	-	(0.07)
Adjustments to liability for unrecognized tax benefits	-	(0.06)	-	(0.06)
Tax effect of adjustments	(0.02)	(0.03)	(0.06)	(0.07)
Adjusted earnings (loss) per share	\$ 0.29	\$ (1.79)	\$ 0.86	\$ (1.59)

\*Please refer to definition of Non-GAAP measures



## Free Cash Flow and Adjusted Free Cash Flow Reconciliation (\$ in millions)

	Three Months Ended June 30,		Six Months Ended June 30,	
	2021	2020	2021	2020
Net cash provided by (used in) operating activities	\$ 167.1	\$ (142.5)	\$ 346.2	\$ (3.1)
Capital expenditures net of proceeds from the sale of property, plant and equipment	(41.2)	(35.0)	(80.8)	(104.2)
Free cash flow	125.9	(177.5)	265.4	(107.3)
Cash payments for restructuring and acquisition-related costs	15.5	15.7	38.9	28.8
Cash payments related to the Malvern fire net of recoveries	(5.3)	-	5.9	-
Adjusted free cash flow	\$ 136.1	\$ (161.8)	\$ 310.2	\$ (78.5)



## Net Debt and Net Leverage Ratio (\$ in millions)

	<b>June 30, 2021</b>
Current portion of long-term debt	\$ 116.5
Long-term debt, net	3,118.5
Total debt, net	3,235.0
Less: cash and cash equivalents	587.7
Net debt at end of period	2,647.3
Adjusted LTM EBITDA	\$ 1,044.1
 Net Leverage Ratio	 2.5X



## Segment Financial Information (\$ in millions)

	Three Months Ended June 30,		Six Months Ended June 30,	
	2021	2020	2021	2020
Segment Sales				
Driveline	\$ 935.4	\$ 375.9	\$ 1,961.5	\$ 1,321.8
Metal Forming	440.1	168.2	929.4	650.3
Total Sales	1,375.5	544.1	2,890.9	1,972.1
Intersegment Sales	(92.2)	(28.8)	(182.5)	(113.3)
Net External Sales	<u>\$ 1,283.3</u>	<u>\$ 515.3</u>	<u>\$ 2,708.4</u>	<u>\$ 1,858.8</u>
Segment Adjusted EBITDA				
Driveline	\$ 151.3	\$ (25.0)	\$ 321.8	\$ 109.5
Metal Forming	71.3	(27.1)	163.7	51.7
Total Segment Adjusted EBITDA	<u>\$ 222.6</u>	<u>\$ (52.1)</u>	<u>\$ 485.5</u>	<u>\$ 161.2</u>

# Supplemental Data



BRINGING THE FUTURE  
FASTER

	<b>Adjusted EBITDA</b>	
	<b>Low End</b>	<b>High End</b>
	<i>(in million)</i>	
Net income	\$ 60	\$ 100
Interest expense	200	200
Income tax expense	15	25
Depreciation and amortization	530	530
Full year 2021 targeted EBITDA	805	855
Restructuring and acquisition-related costs	60	60
Other	10	10
Full year 2021 targeted Adjusted EBITDA	<u>\$ 875</u>	<u>\$ 925</u>

	<b>Adjusted EBITDA</b>	
	<b>Low End</b>	<b>High End</b>
	<i>(in million)</i>	
Net cash provided by operating activities	\$ 530	\$ 585
Capital expenditures net of proceeds from the sale of property, plant and equipment	(240)	(220)
Full year 2021 targeted Free Cash Flow	290	365
Cash payments for restructuring and acquisition-related costs	60	60
Full year 2021 targeted Adjusted Free Cash Flow	<u>\$ 350</u>	<u>\$ 425</u>

# Definition of Non-GAAP Measures



BRINGING THE FUTURE  
FASTER

## **EBITDA and Adjusted EBITDA**

We define EBITDA to be earnings before interest expense, income taxes, depreciation and amortization. Adjusted EBITDA is defined as EBITDA excluding the impact of restructuring and acquisition-related costs, debt refinancing and redemption costs, loss on sale of a business, impairment charges, pension settlements and non-recurring items. We believe that EBITDA and Adjusted EBITDA are meaningful measures of performance as they are commonly utilized by management and investors to analyze operating performance and entity valuation. Our management, the investment community and the banking institutions routinely use EBITDA and Adjusted EBITDA, together with other measures, to measure our operating performance relative to other Tier 1 automotive suppliers. We also use Segment Adjusted EBITDA as the measure of earnings to assess the performance of each segment and determine the resources to be allocated to the segments. EBITDA and Adjusted EBITDA should not be construed as income from operations, net income or cash flow from operating activities as determined under GAAP. Other companies may calculate EBITDA and Adjusted EBITDA differently.

## **Adjusted Earnings (Loss) Per Share**

We define Adjusted earnings (loss) per share to be diluted earnings per share excluding the impact of restructuring and acquisition-related costs, debt refinancing and redemption costs, loss on sale of a business, impairment charges, pension settlements, certain accelerated depreciation and non-recurring items, including the tax effect thereon. We believe Adjusted earnings (loss) per share is a meaningful measure as it is commonly utilized by management and investors in assessing ongoing financial performance that provides improved comparability between periods through the exclusion of certain items that management believes are not indicative of core operating performance and which may obscure underlying business results and trends. Other companies may calculate Adjusted earnings (loss) per share differently.

## **Free Cash Flow and Adjusted Free Cash Flow**

We define free cash flow to be net cash provided by operating activities less capital expenditures net of proceeds from the sale of property, plant and equipment. Adjusted free cash flow is defined as free cash flow excluding the impact of cash payments for restructuring and acquisition-related costs and cash payments related to the Malvern fire, including payments for capital expenditures, net of recoveries. We believe free cash flow and Adjusted free cash flow are meaningful measures as they are commonly utilized by management and investors to assess our ability to generate cash flow from business operations to repay debt and return capital to our stockholders. Free cash flow and Adjusted free cash flow are also key metrics used in our calculation of incentive compensation. Other companies may calculate free cash flow and Adjusted free cash flow differently.

## **Net Debt and Net Leverage Ratio**

We define net debt to be total debt, net less cash and cash equivalents. We define Net Leverage Ratio to be net debt divided by the trailing 12 months of Adjusted EBITDA. We believe that Net Leverage Ratio is a meaningful measure of financial condition as it is commonly used by management, investors and creditors to assess capital structure risk. Other companies may calculate Net Leverage Ratio differently.

## **Liquidity**

We define Liquidity as cash on hand plus amounts available on our revolving credit facility and foreign credit facilities.

## **US SAAR**

We define US SAAR as the seasonally adjusted annual rate of light vehicle sales in the United States.

## **Accelerated Depreciation**

In the first quarter of 2021, one of our largest customers announced their intention to cease production operations in Brazil in 2021 as part of their restructuring actions. As such, we have accelerated depreciation on certain property, plant and equipment beginning in the first quarter of 2021. In the first six months of 2020, we accelerated depreciation for certain assets that were idled as a result of our largest customer exiting their operations in Thailand, which they announced in the first quarter of 2020.

