



**Delivering
POWER.**

BARCLAYS 2016 GLOBAL AUTOMOTIVE CONFERENCE

NOVEMBER 17, 2016

Forward Looking Statements



Some of the information presented in this document and discussions that follow, including, without limitation, statements with respect to the transaction and the anticipated consequences and benefits of the transaction, the targeted close date for the transaction, product development, market trends, price, expected growth and earnings, cash flow generation, costs and cost synergies, portfolio diversification, economic trends, outlook and all other information relating to matters that are not historical facts may constitute forward-looking statements within the meaning of the Private Securities Litigation Reform Act of 1995. There can be no assurance that actual results will not differ materially. Factors that could cause actual results to differ materially include, without limitation: the receipt and timing of necessary regulatory approvals; the ability to finance the transaction; the ability to successfully operate and integrate MPG's operations and realize estimated synergies; reduced purchases of our products by General Motors Company (GM), FCA US LLC (FCA), or other customers; reduced demand for our customers' products (particularly light trucks and sport utility vehicles (SUVs) produced by GM and FCA); our ability to develop and produce new products that reflect market demand; lower-than-anticipated market acceptance of new or existing products; our ability to respond to changes in technology, increased competition or pricing pressures; our ability to attract new customers and programs for new products; our ability to achieve the level of cost reductions required to sustain global cost competitiveness; supply shortages or price increases in raw materials, utilities or other operating supplies for us or our customers as a result of natural disasters or otherwise; liabilities arising from warranty claims, product recall or field actions, product liability and legal proceedings to which we are or may become a party, or the impact of product recall or field actions on our customers; our ability or our customers' and suppliers' ability to successfully launch new product programs on a timely basis; our ability to realize the expected revenues from our new and incremental business backlog; risks inherent in our international operations (including adverse changes in political stability, taxes and other law changes, potential disruptions of production and supply, and currency rate fluctuations, including those resulting from the United Kingdom's vote to exit the European Union); negative or unexpected tax consequences; our ability to consummate and integrate acquisitions and joint ventures; global economic conditions; our ability to maintain satisfactory labor relations and avoid work stoppages; our suppliers', our customers' and their suppliers' ability to maintain satisfactory labor relations and avoid work stoppages; price volatility in, or reduced availability of, fuel; our ability to protect our intellectual property and successfully defend against assertions made against us; our ability to successfully implement upgrades to our enterprise resource planning systems; our ability to attract and retain key associates; availability of financing for working capital, capital expenditures, research and development (R&D) or other general corporate purposes including acquisitions, as well as our ability to comply with financial covenants; our customers' and suppliers' availability of financing for working capital, capital expenditures, R&D or other general corporate purposes; changes in liabilities arising from pension and other postretirement benefit obligations; risks of noncompliance with environmental laws and regulations or risks of environmental issues that could result in unforeseen costs at our facilities; adverse changes in laws, government regulations or market conditions affecting our products or our customers' products (such as the Corporate Average Fuel Economy (CAFE) regulations); our ability or our customers' and suppliers' ability to comply with the Dodd-Frank Act and other regulatory requirements and the potential costs of such compliance; and the other factors detailed from time to time in the reports we file with the SEC, including those described under "Risk Factors" in our Annual Report on Form 10-K and our Quarterly Reports on Form 10-Q. These forward-looking statements speak only as of the date of this communication. We expressly disclaim any obligation or undertaking to disseminate any updates or revisions to any forward-looking statement contained herein to reflect any change in our expectations with regard thereto or any change in events, conditions or circumstances on which any such statement is based.

Information with respect to MPG, including non-GAAP information is taken or derived from MPG's public filings and management estimates and we take no responsibility for the accuracy or completeness of such information. It should be noted that this presentation contains certain financial measures, including Adjusted EBITDA and free cash flow, that are not required by, or presented in accordance with, accounting principles generally accepted in the United States, or GAAP. These measures are presented here to provide additional useful measurements to review our operations, provide transparency to investors and enable period-to-period comparability of financial performance. A description of non-GAAP financial measures that we use to evaluate our operations and financial performance, and reconciliation of these non-GAAP financial measures to the most directly comparable financial measures calculated and reported in accordance with GAAP, can be found starting on slide 22 under "Reconciliation of Non-GAAP Measures".

Important Information for Stockholders and Investors

This announcement is provided for informational purposes only and is neither an offer to purchase nor a solicitation of an offer to sell shares of AAM or MPG. Subject to future developments, AAM and MPG will file a joint proxy statement/prospectus with the SEC in connection with the proposed transaction. **Investors are urged to read the joint proxy statement/prospectus and other documents filed by AAM and MPG with the SEC in connection with the proposed transaction when they become available, as these documents will contain important information.** Those documents, if and when filed, as well as AAM's and MPG's other public filings with the SEC, may be obtained without charge at the SEC's website at www.sec.gov. Investors may also obtain a free copy of the joint proxy statement/prospectus and the filings with the SEC that will be incorporated by reference in the joint proxy statement/prospectus by directing a request to AAM at www.aam.com, or to MPG at www.mpgdriven.com.

Participants in Solicitation

AAM, MPG and their respective directors, executive officers and other members of their management and employees may be deemed to be participants in a solicitation of proxies from their respective stockholders in connection with the proposed transaction. Information regarding AAM's directors and executive officers is available in AAM's proxy statement for its 2016 annual meeting of stockholders, which was filed with the SEC on March 24, 2016. Information regarding MPG's directors and executive officers is available in MPG's proxy statement for its 2016 annual meeting of stockholders, which was filed with the SEC on April 11, 2016. Other information regarding the participants in the proxy solicitation and a description of their direct and indirect interests, by security holdings or otherwise, will be contained in the joint proxy statement/prospectus and other relevant materials to be filed with the SEC when they become available. These documents can be obtained free of charge from the sources indicated above.

2016 Financial Outlook

As updated on November 3, 2016



	2016 Targets
Net Sales	≈ \$3.95B
Adjusted EBITDA* Margin	≈ 15.25% - 15.5%
Free Cash Flow*	≈ \$160M ¹

On track for record sales and profit in 2016!

¹ Includes an estimated \$30 million related to transfer pricing payments to Mexican tax authorities.

* For definitions of terms, please see the attached appendix.

Update on GM Next Generation Full-Size Trucks

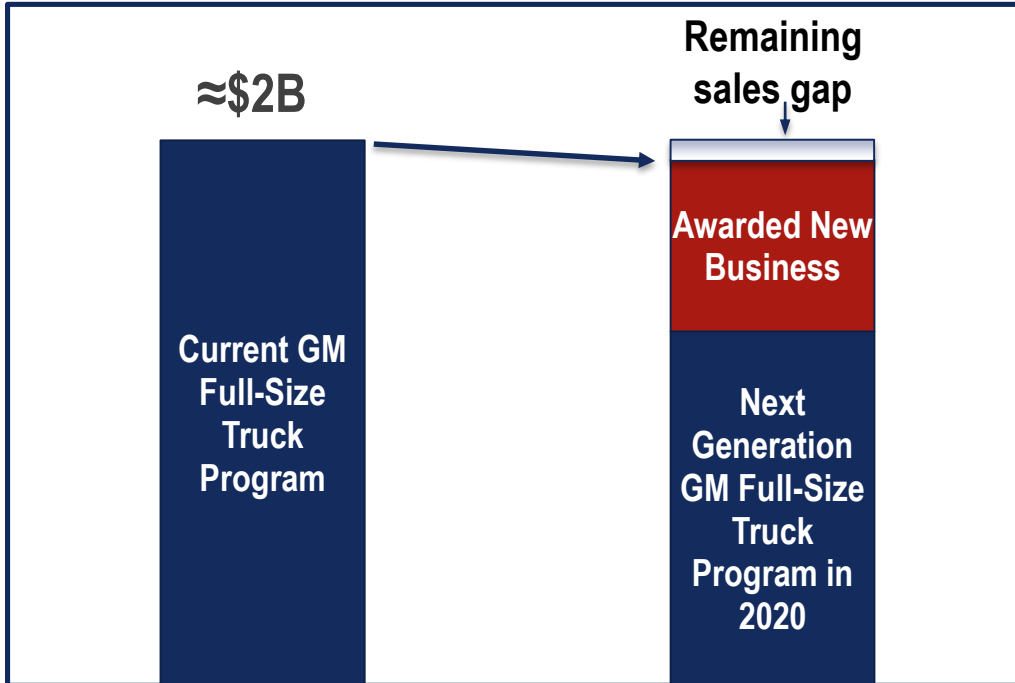

- We have covered 90% of the sourcing impact of GM's next generation full-size truck program
- The new and incremental business wins are coming in at strong margins

We are nearly complete in offsetting the revenue impact of GM's sourcing decision through new business wins



**Delivering
POWER[®]**

AAM'S ACQUISITION OF MPG

(METALDYNE PERFORMANCE GROUP)

Increased Global Scale | Expanded Product Portfolio | Accelerated Diversification | Enhanced Cash Flow Generation

Compelling Strategic Acquisition



Creates a
Global leader in
powertrain,
drivetrain and
driveline

**Diversified
global customer
base**
and end markets

**Complementary
technologies**
focused on
light-weighting,
fuel efficiency,
vehicle safety and
performance solutions

**Stronger
financial profile**
through greater size,
scale and enhanced
**cash flow
generation**

Powerful **Industrial
logic** and significant
synergies

Driving growth and long-term value for all key stakeholders

Transaction Details



Consideration

- Total consideration of approximately \$1.6 billion. For each share of MPG common stock, shareholders will receive \$13.50 in cash and 0.5 of a share of AAM common stock
- Implied multiple of 6.8x Adjusted EBITDA* based on 2016E – 5.5x based on 2016E including synergies

Financial Impact

- Accretive to EPS and free cash flow* in the first full year of ownership
- Targeted annual run-rate cost reduction synergies of between \$100 to \$120 million by 2018

Financing

- Fully committed debt financing in place to fund the cash portion of the transaction
- Expected liquidity of the combined company to be in excess of \$1 billion

Cash Flow / Leverage Profile

- Expected pro forma 2016E Net Debt* / Adjusted EBITDA of approximately 3.5x at closing; Approximately 3.2x at closing when adjusted for full annual run rate of synergies
- Targeting to reduce net leverage profile to 2x by the end of 2019 through profitable growth and debt reduction funded by strong free cash flow generation

Closing / Governance

- Expected to close in the first half of 2017, subject to regulatory and shareholder approvals, as well as other customary closing conditions
- AAM will expand its Board of Directors to include three designees of American Securities, including MPG CEO George Thanopoulos

Significantly Enhanced Scale and Profitability

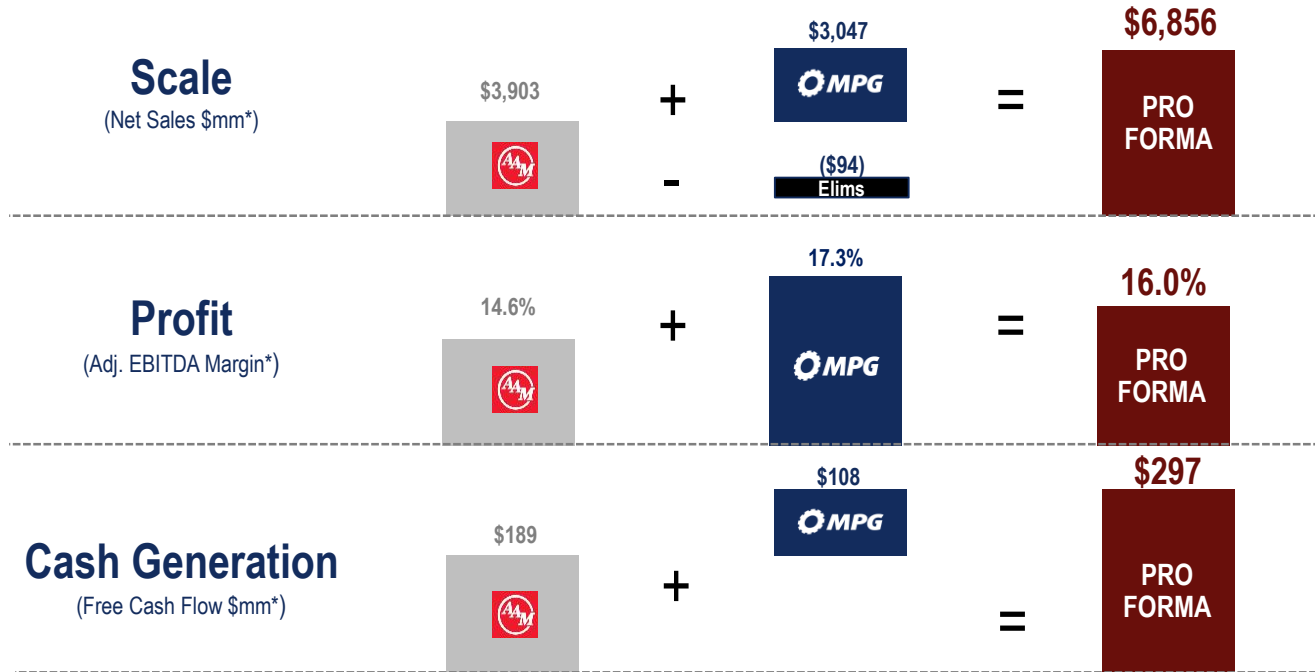

- Significant increase in total served market
- Content on 90% of light vehicles produced in North America and on all of the top 10 North American platforms
- Including successful execution of our cost reduction synergy plan - potential to generate **over \$400 million** in annual free cash flow

Greater capital resources creates long-term value for stakeholders

Comprehensive Solutions from Engine to Driveline



- Rear and front axles
- Rear drive modules
- Power transfer units
- Driveshafts
- Transfer cases
- Electric drive units
- Ring / pinion gears
- Axle / transmission shafts
- Differential gears
- Transmission gears



- Axle carriers
- Differential cases
- Control arms
- Turbo charger housings
- Brackets
- Suspension components
- Transmission modules
- Differential assemblies
- Aluminum valve bodies
- Vibration control systems
- Connecting rods
- VVT products

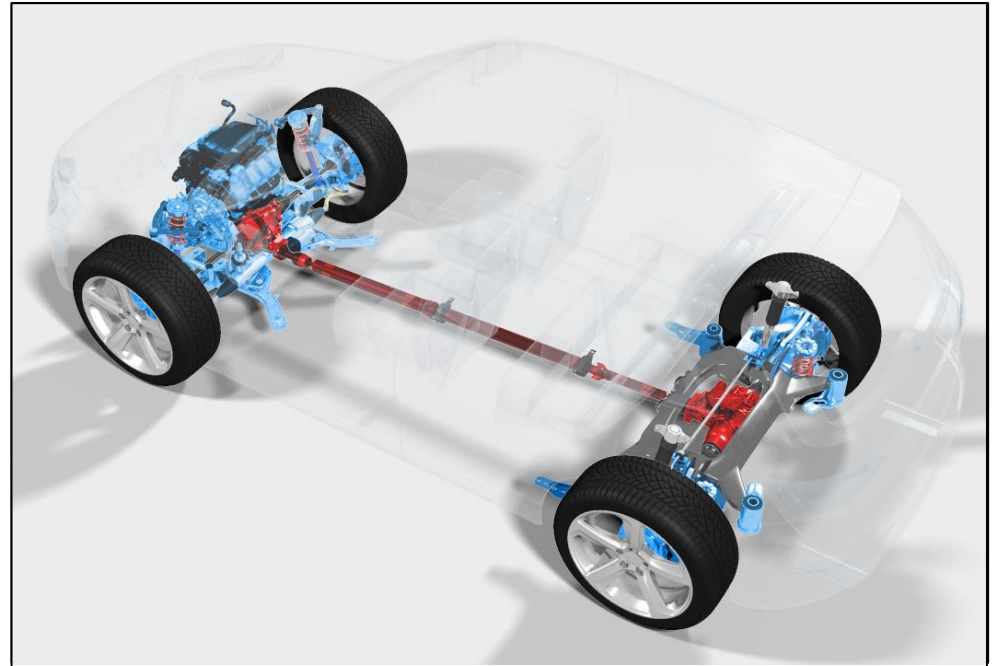

The integration of our product portfolios and technologies provides exciting opportunities to increase content-per-vehicle

Expanded Product Portfolio

- Additional powertrain, forging and casting products build on AAM's legacy driveline strength
- Expands AAM's reach into commercial vehicle and industrial equipment markets
- AAM's reliance on GM's full-size truck and SUV segment is significantly reduced

AAM 2015 External Sales by Product

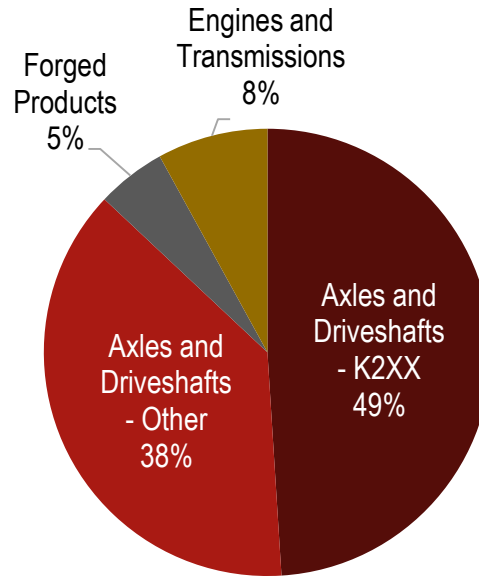

Pro forma 2015 External Sales by Product

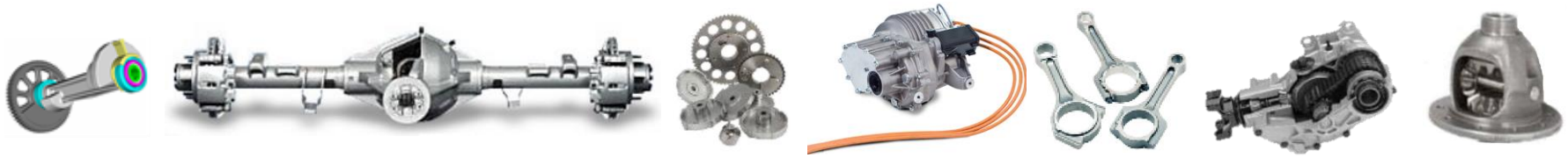
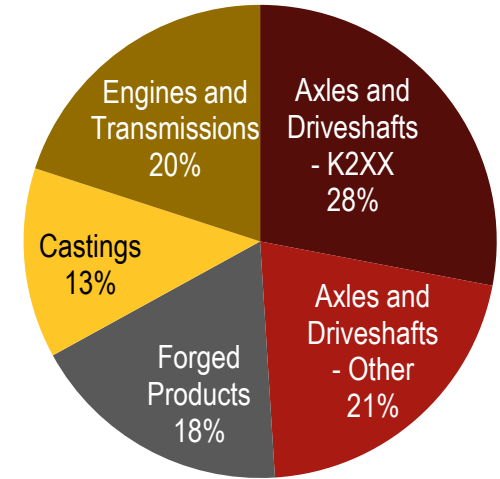

Accelerated Customer Diversification

AAM 2015 Sales by Customer

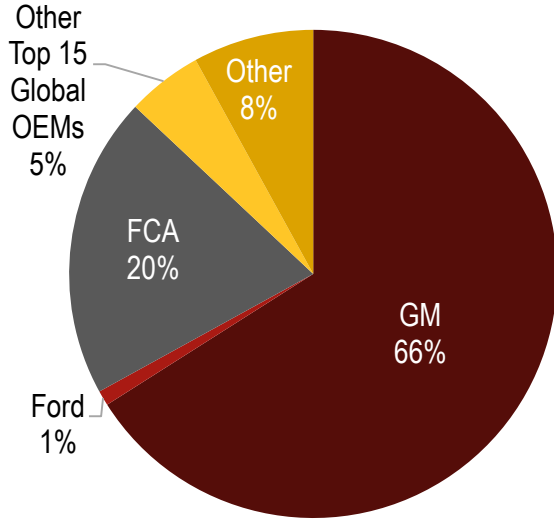

Pro forma 2015 Sales by Customer

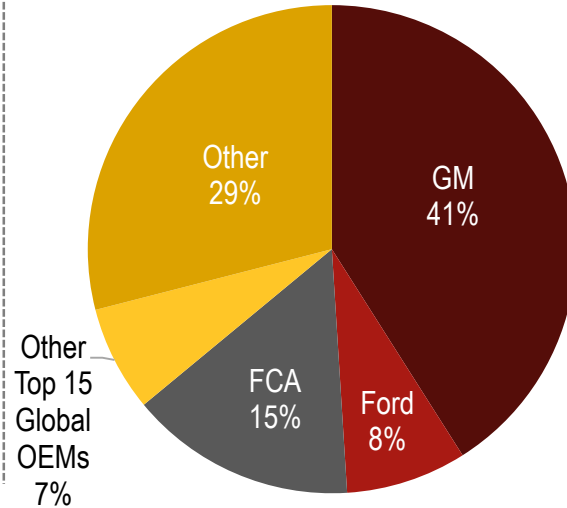

Pro forma 2020E Sales by Customer

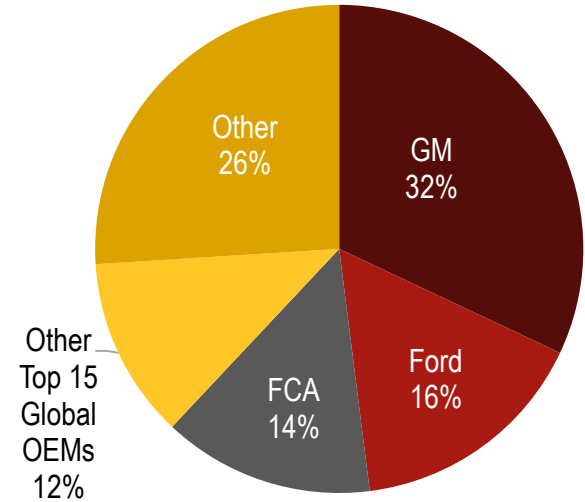

FIAT CHRYSLER AUTOMOBILES



* Top 15 Global OEMs determined based on total 2015 sales

Anticipated Synergies

Sources of Cost Savings	Targeted Annual Profit Impact
Overhead <ul style="list-style-type: none">Optimize operating structureElimination of redundant public company costs	≈ \$45 - \$50 million
Purchasing <ul style="list-style-type: none">Combine global purchasing to leverage larger scaleDirect and indirect material opportunitiesInsourcing initiatives	≈ \$45 - \$50 million
Other Cost Savings <ul style="list-style-type: none">Manufacturing initiativesPlant loading optimization / facility rationalization	≈ \$10 - \$20 million
Total Targeted Annual Improvement	≈ \$100 - \$120 million

Timing and Cost to Achieve

Targeting 70% of expected annual run rate savings by the end of the first full year and 100% in the second full year

We estimate the costs required to achieve our synergy plan are approximately equal to one year of savings

US SAAR and NA Production Assumptions

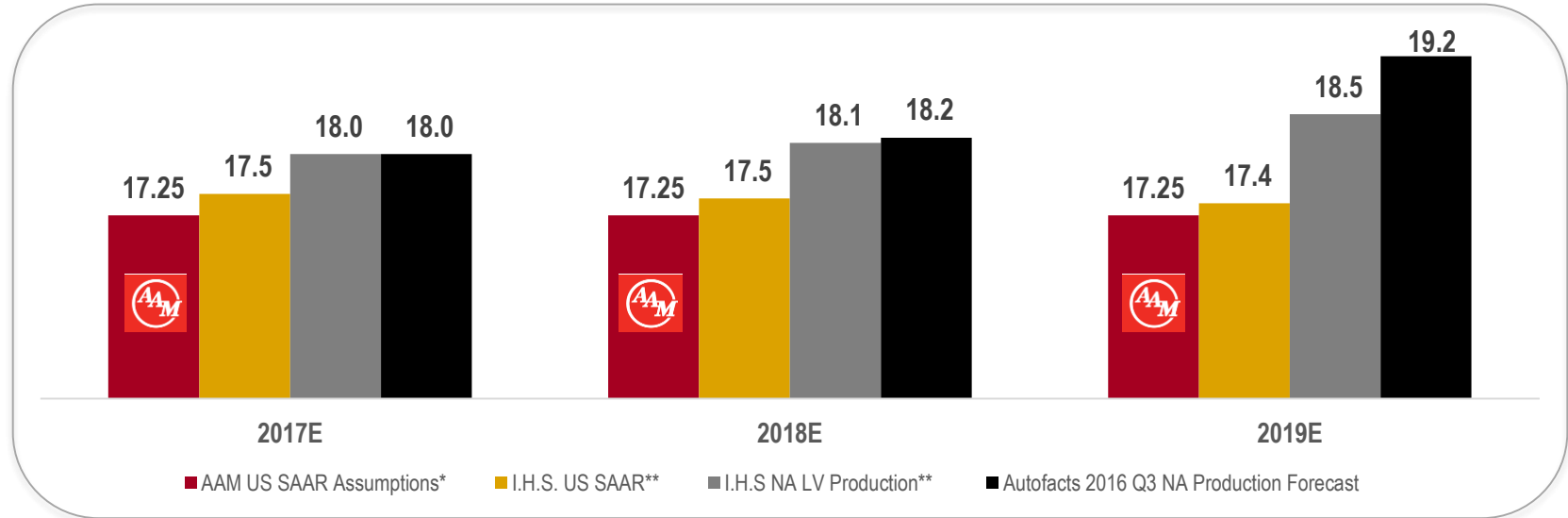

- US SAAR estimated to average between 17.0 to 17.5 million units
 - Compared to IHS estimates of 17.4/17.5 million units
- I.H.S. / Autofacts estimate an increase in North American production due to growing exports
- I.H.S. estimates continued strong light truck/SUV/CUV sales mix trending to > 60%**
- AAM also assumes a moderate recovery in the commercial vehicle and industrial markets

*The mid-point of 17.25 million units used for charting purposes.

** As of November 11, 2016.

Pro Forma 2017 – 2019 Financial Targets



	2017 – 2019 Pro Forma Financial Targets
Sales CAGR*	Targeting a range of 3% to 5% during the period 2017 - 2019, including the impact of launching over \$1 billion of new and incremental business backlog
Adjusted EBITDA* margin	Targeting a range of 17% to 18% of sales by 2018, including the achievement of \$100 to \$120 million in cost reduction synergies
Adjusted Free Cash Flow*	Targeting a range of 5% to 7% of sales through 2019
Capital Expenditures (Cap Ex)	Targeting \approx 8% of sales in 2017, reducing to < 6% of sales by 2019

*For definitions of terms, please see the attached appendix

Expected Pro Forma EBITDA vs. Cash Payments

- Targeting Adjusted EBITDA well above projected cash requirements
- Variable cost structure allows for flexibility during periods of lower volumes
- Positioned to be cash breakeven in a 25% - 30% downturn scenario

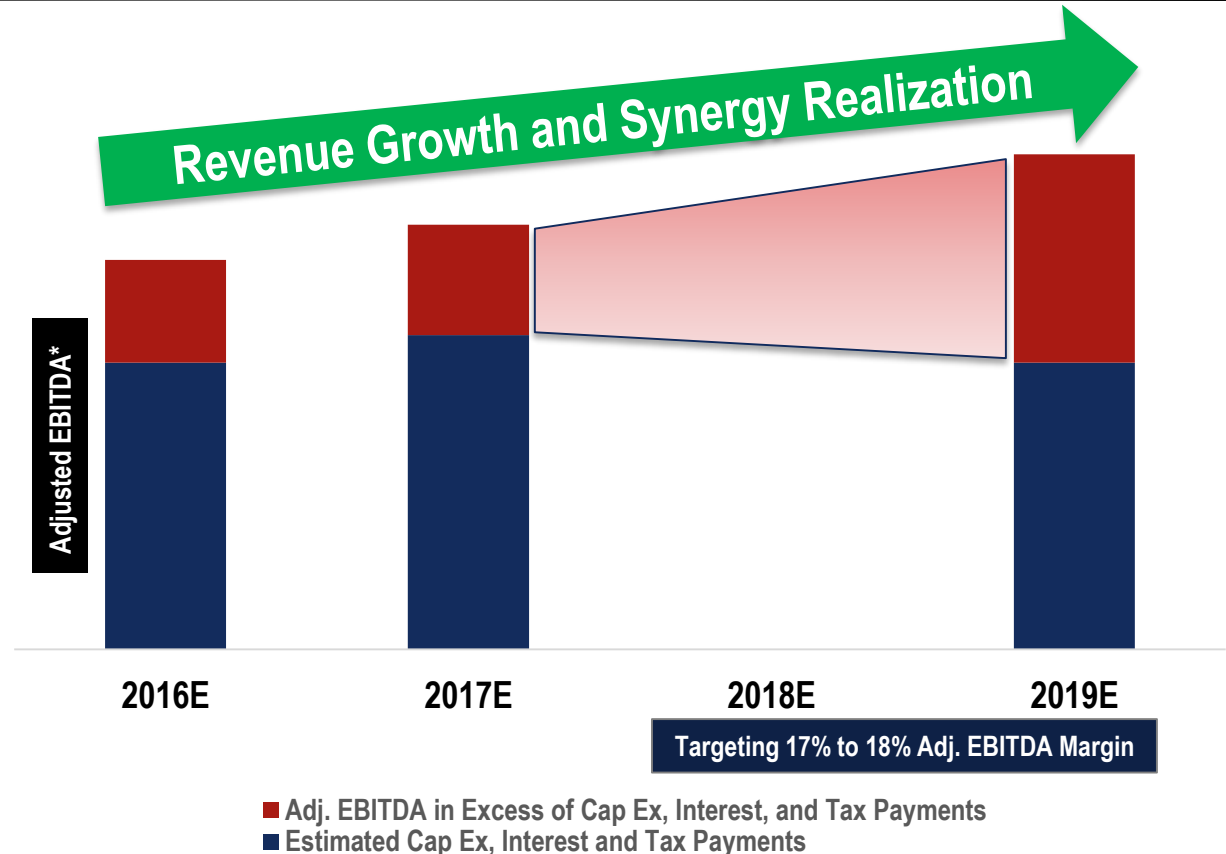

*For definitions of terms, please see the attached appendix

Pro Forma Debt Paydown

Pro Forma Net Debt and Net Leverage Ratio⁽¹⁾

Liquidity⁽³⁾

Debt Maturities⁽⁴⁾

Net Debt and Leverage Ratio

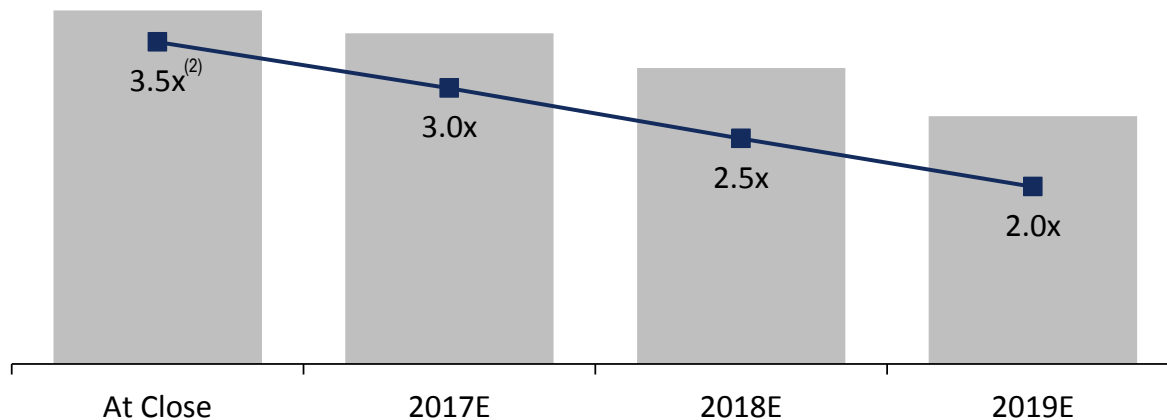

≈ \$1B

> \$1B

> \$1B

> \$1B

Minimal

Minimal

Minimal

5.125% \$200mm Note Due 2/15/19

Minimal in 2020

7.750% \$200mm Note Due 11/15/19

Note: Future performance reflects company estimates.; (1) Assumes 3/31/17 close; (2) Reflects 2016E EBITDA, excluding synergies, pro forma for the acquisition of Brillion by MPG; (3) Reflects combined revolver availability and cash balance; (4) AAM expects minimal amortization and foreign debt payments

*For definitions of terms, please see the attached appendix



- Increased size and scale
- Customer and product diversification
- Enhanced geographic footprint
- Served market and content per vehicle expansion
- Strong profit and free cash flow margins
- Identifiable cost synergies of \approx \$100 – 120 million
- Extended debt maturity profile

Stronger Financial Profile and Enhanced Cash Flow Generation

Powerful Industrial Logic

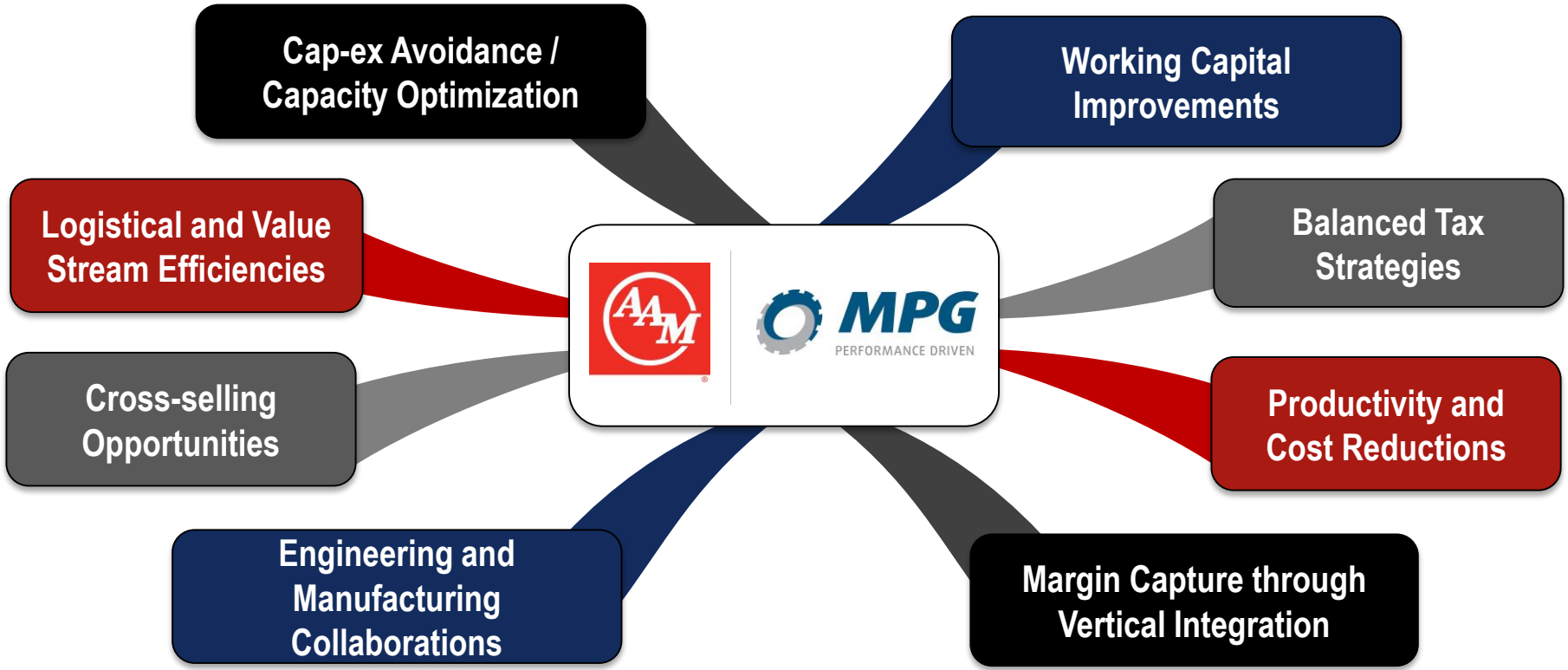

Numerous value creation opportunities beyond synergies



**Delivering
POWER.**

APPENDIX

Shareholder Value Enhancement Opportunity



(\$ in billions, except per share data)

	Pro Forma Value		
	At Illustrative Pro Forma Multiples		
	-0.5x	Peer Average	+0.5x
Projected 2016 Adj. EBITDA w/ synergies ⁽¹⁾	\$ 1.2	\$ 1.2	\$ 1.2
Illustrative Multiple	5.25x	5.71x ⁽⁵⁾	6.25x
Implied Enterprise Value	\$ 6.3	\$ 6.9	\$ 7.5
Net Debt ⁽²⁾	\$ (3.9)	\$ (3.9)	\$ (3.9)
Implied Equity Value	\$ 2.4	\$ 3.0	\$ 3.6
<i>Fully Diluted Shares Outstanding (millions)</i> ⁽³⁾	114	114	114
Implied Share Price	\$ 21.05	\$ 25.89	\$ 31.58
<i>% Premium to 30-Day VWAP</i> ⁽⁴⁾	45.9%	79.4%	118.8%

Notes: Future performance reflects company estimates; (1) Includes \$110 million of annual run-rate synergies; (2) Reflects estimated net debt and non-controlling interest at close; (3) Reflects fully diluted shares outstanding at close; (4) Based on 30-day VWAP of \$14.43, as of November 14, 2016; (5) Per Bloomberg, Average of Peers' EV / 2016 Adj. EBITDA multiples of 5.71 as of November 14, 2016. Peer group as defined in AAM's 2015 Annual Report.

Reconciliation of Non-GAAP Measures



In addition to the results reported in accordance with accounting principles generally accepted in the United States of America (GAAP) included within this presentation, we have provided certain information, which includes non-GAAP financial measures. Such information is reconciled to its closest GAAP measure in accordance with Securities and Exchange Commission rules and is included in the following slides.

Certain of the forward-looking financial measures included in this presentation are provided on a non-GAAP basis. A reconciliation of pro forma forward-looking financial measures to the most directly comparable financial measures calculated and presented in accordance with GAAP is not practical given the difficulty of projecting event driven transactional and other non-core operating items in any future period. The magnitude of these items, however, may be significant.

Reconciliation of Non-GAAP Measures



AAM Full Year 2016 Outlook

	Adjusted EBITDA Margin	
	Low End	High End
	(\$ in millions, except percentages)	
Net income	\$ 235	\$ 245
Income tax expense	65	65
Interest expense	94	94
Depreciation and amortization	205	205
Full year 2016 targeted EBITDA	\$ 599	\$ 609
Special charges	3	3
Other non-recurring items	—	—
Full year 2016 targeted Adjusted EBITDA	\$ 602	\$ 612
Full year 2016 targeted sales	\$ 3,950	\$ 3,950
Full year 2016 targeted Adjusted EBITDA margin	15.25 %	15.5 %

	Free Cash Flow
	(\$ in millions)
Net cash provided by operating activities	\$ 400
Less: Purchases of property, plant and equipment, net of proceeds from sale of property, plant and equipment and government grants	(240)
Full year 2016 targeted free cash flow	\$ 160

Due to the unpredictability of future events and the impractical nature of estimating the impact of such events, the foregoing forward-looking information does not reflect potential special charges, asset impairments, income tax adjustments, debt refinancing activities or other possible adjustments to EBITDA and free cash flow.

Reconciliation of Non-GAAP Measures



2015 Full Year Earnings before Interest, Income Taxes, Depreciation and Amortization (EBITDA) and Adjusted EBITDA Reconciliation Schedule

(\$ in millions)

	<u>AAM</u>	<u>MPG</u>	<u>PRO FORMA</u>
Net income, as reported	\$ 235.6	\$ 125.8	\$ 361.4
Interest expense	99.2	107.5	206.7
Income tax expense	37.1	48.1	85.2
Depreciation and amortization	198.4	229.8	428.2
EBITDA, as defined	<u>\$ 570.3</u>	<u>\$ 511.2</u>	<u>\$ 1,081.5</u>
Add: Debt related losses and expenses	0.8	2.1	2.9
Add: Special charges and non-recurring items	—	14.6	14.6
Adjusted EBITDA	<u>\$ 571.1</u>	<u>\$ 527.9</u>	<u>\$ 1,099.0</u>
as % of net sales	<u>14.6 %</u>	<u>17.3 %</u>	<u>16.0 %</u>

Reconciliation of Non-GAAP Measures



2015 Full Year Free Cash Flow (\$ in millions)

	<u>AAM</u>	<u>MPG</u>	<u>PRO FORMA</u>
Net cash provided by operating activities	\$ 377.6	\$ 330.0	707.6
Less: Purchases of property, plant & equipment, net of proceeds from sale of property, plant & equipment and from government grants	<u>(188.1)</u>	<u>(222.3)</u>	<u>(410.4)</u>
Free cash flow	<u>\$ 189.5</u>	<u>\$ 107.7</u>	<u>\$ 297.2</u>

Reconciliation of Non-GAAP Measures



We define EBITDA to be earnings before interest expense, income taxes, depreciation and amortization. Adjusted EBITDA excludes the impact of debt related losses and expenses and special charges and other non-recurring items. We believe EBITDA and Adjusted EBITDA are meaningful measures of performance as they are commonly utilized by management and investors to analyze operating performance and entity valuation. Our management, the investment community and banking institutions routinely use EBITDA and Adjusted EBITDA, together with other measures, to measure our operating performance relative to other Tier 1 automotive suppliers. EBITDA and Adjusted EBITDA should not be construed as income from operations, net income or cash flow from operating activities as determined under GAAP. Other companies may calculate EBITDA and Adjusted EBITDA differently.

We define free cash flow to be net cash provided by operating activities less capital expenditures net of proceeds from the sale of property, plant and equipment and government grants. Adjusted free cash flow excludes the impact of cash payments for costs required to achieve our synergy plan. We believe free cash flow and adjusted free cash flow are meaningful measures as it is commonly utilized by management and investors to assess our ability to generate cash flow from business operations to repay debt and return capital to our stockholders. Free cash flow is also a key metric used in our calculation of incentive compensation. Other companies may calculate free cash flow and adjusted free cash flow differently.

We define net debt to be total debt, net less cash and cash equivalents.

We define net leverage ratio to be net debt divided by Adjusted EBITDA. We believe that net leverage ratio is a meaningful measure of financial condition as it is commonly used by management, investors and creditors to assess capital structure risk. Other companies may calculate net leverage ratio differently.

We define CAGR to be the compound annual growth rate of sales.